

**Selected papers on low-energy
quantum gravity**

Michael A. Ivanov

Библиотека БГУИР

Contents

0.1	Preface	5
1	Manifestations of the graviton background	6
1.1	Introduction	6
1.2	Photon energy losses	8
1.3	An additional relaxation of a photon flux	10
1.4	Comparison of the redshift model with supernova cosmology data	11
1.5	Possibilities to verify the conjecture	12
1.6	Deceleration of massive bodies	13
1.7	Estimates of a cross-section	15
1.8	Conclusion	17
2	Model of graviton-dusty universe	22
2.1	Introduction	23
2.2	Hypothetical superstrong gravitational quantum interaction	23
2.3	Utilization of energy, which is lost	24
2.4	Conclusion	26
3	Screening the graviton background	30
3.1	Introduction	31
3.2	Screening the graviton background	32
3.3	Graviton pairing	34
3.4	Computation of Newton's constant	36
3.5	Why and when gravity is geometry	39
3.6	Conclusion	41
4	A main engine of the universe	46

5	May gravitons be super-strong interacting	52
5.1	Introduction	52
5.2	A gravitational attraction due to the background	53
5.3	Cosmological consequences of the model	54
5.4	How to verify the main conjecture of this approach	55
5.5	Conclusion	56
6	Another picture of the universe	59
6.1	Introduction	60
6.2	Passing photons through the graviton background	62
6.2.1	Forehead collisions with gravitons	62
6.2.2	Non-forehead collisions with gravitons	63
6.2.3	Comparison with supernova data	65
6.2.4	Computation of the Hubble constant	68
6.3	Deceleration of massive bodies	69
6.4	Gravity as the screening effect	71
6.4.1	Pressure force of single gravitons	71
6.4.2	Graviton pairing	73
6.4.3	A connection between the two fundamental constants	74
6.5	Some cosmological consequences of the model	76
6.6	Conclusion	79
7	Low-energy quantum gravity	84
7.1	Introduction	85
7.2	Passing photons through the graviton background	86
7.3	Gravity as the screening effect	88
7.3.1	Pressure force of single gravitons	89
7.3.2	Graviton pairing	90
7.3.3	A connection between the two fundamental constants	91
7.3.4	Restrictions on a geometrical language in gravity	93
7.4	Some cosmological consequences of the model	95
7.5	How to verify the main conjecture	96
7.6	Gravity in a frame of non-linear QED	98
7.7	Conclusion	100
8	Galaxy number counts	105
8.1	Introduction	106
8.2	The galaxy number counts-redshift relation	107

8.3	The galaxy luminosity function	108
8.4	Quasar number counts	113
8.5	Conclusion	116
9	Hubble diagrams of soft and hard radiation	118
9.1	Introduction	119
9.2	Limit cases of the Hubble diagram	119
9.3	Conclusion	125
10	A few remarks about the Pioneer anomaly	127
11	A transition to asymptotic freedom	131
11.1	Introduction	131
11.2	The screened portion of gravitons	132
11.3	A transition to asymptotic freedom	135
11.4	Conclusion	137
12	How to verify the redshift mechanism	139
12.1	Introduction	139
12.2	Possibilities to verify the redshift mechanism	140
12.3	Conclusion	144
13	Lorentz symmetry violation	147
13.1	Introduction	147
13.2	Time delay of photons	148
13.2.1	Evaluation of the lifetime of a virtual photon	149
13.2.2	The case of constancy of the proper lifetime	150
13.2.3	An influence of graviton pairing	151
13.3	Conclusion	153
14	No-time-dilation corrected data	155
14.1	Introduction	155
14.2	Correction for no time delation	156
14.3	Conclusion	158
15	Another possible interplay	161

0.1 Preface

A collection of author's papers on low-energy quantum gravity is presented in the book. These papers were written in the last decade. In the papers, main results of author's work in a non-geometrical approach to quantum gravity are described, among them: the quantum mechanism of classical gravity giving a possibility to compute the Newton constant; asymptotic freedom at short distances; an interaction of photons with the graviton background leading to the important cosmological consequences; the time delay of photons due to interactions with gravitons. A quantum mechanism of classical gravity based on an existence of this sea of gravitons is described for the Newtonian limit. This mechanism needs graviton pairing and "an atomic structure" of matter for working it. If the considered quantum mechanism of classical gravity is realized in the nature, then an existence of black holes contradicts to Einstein's equivalence principle. It is shown that in this approach the two fundamental constants - Hubble's and Newton's ones - should be connected between themselves. The theoretical values of the constants are computed. In this approach, every massive body would be decelerated due to collisions with gravitons that may be connected with the Pioneer anomaly and the problem of dark matter. It is shown that the predicted and observed values of deceleration of NASA probes are in good agreement.

It is also shown by the author that if gravitons are super-strong interacting particles and the low-temperature graviton background exists, the basic present-day cosmological conjecture about the nature of redshifts may be false. In this case, a full magnitude of cosmological redshift would be caused by interactions of photons with gravitons. Non-forehead collisions with gravitons will lead to a very specific additional relaxation of any photonic flux. It gives a possibility of another interpretation of supernovae 1a data - without any kinematics and introduction of dark energy. A few possibilities to verify model's predictions are considered: the specialized ground-based laser experiment; a deceleration of massive bodies and the Pioneer anomaly; a non-universal character of the Hubble diagram for soft and hard radiations; galaxy/quasar number counts.

Michael A. Ivanov

*Physics Dept., Belarus State University of Informatics and Radioelectronics,
Minsk, Republic of Belarus.*

Home page: www.ivanovma.narod.ru. E-mail: michai@mail.by.

Chapter 1

Possible manifestations of the graviton background

1

Possible effects are considered which would be caused by a hypothetical superstrong interaction of photons or massive bodies with single gravitons of the graviton background. If full cosmological redshift magnitudes are caused by the interaction, then the luminosity distance in a flat non-expanding universe as a function of redshift is very similar to the specific function which fits supernova cosmology data by Riess et al. From another side, in this case every massive body, slowly moving relatively to the background, would experience a constant acceleration, proportional to the Hubble constant, of the same order as a small additional acceleration of Pioneer 10, 11.

PACS: 98.70.Vc, 98.60.Eg, 04.60.+n, 95.55.Pe

1.1 Introduction

In the standard cosmological model [1], as well as in inflationary cosmological models [2], redshifts of remote objects are explained by expansion of the universe. A model of expansion gives an exact dependence of a distance r from an observer to a source on a redshift z . There is a known uncertainty of estimates of the Hubble constant H because of difficulties to establish a scale

¹Gen.Rel.Grav. 33 (2001) 479-490; Erratum-ibid. 35 (2003) 939-940. [arXiv:astro-ph/0005084v2]

of cosmological distances which is independent on redshifts [3, 4]. Today, as one could think, there are not obvious observant facts which would demand some alternative model to interpret an origin of redshifts. But one cannot exclude that the effect may have some non-dopplerian nature.

In alternative cosmological models, which are known as "tired-light" ones, the cosmological redshift is considered namely as a non-dopplerian effect. Several mechanisms for photon energy loss have been supposed [5, 6]. There exist different opinions, what a cosmological model makes the better fit to the existing astrophysical data on some kinds of cosmological tests (compare, for example, [7, 8] with [6]).

In this paper, possible manifestations of the graviton background in a case of hypothetical superstrong gravitational quantum interaction are considered. From one side, the author brings the reasons that a quantum interaction of photons with the graviton background would lead to redshifts of remote objects too. The author considers a hypothesis about an existence of the graviton background to be independent from the standard cosmological model. One cannot affirm that such an interaction is the only cause of redshifts. It is possible, that the one gives a small contribution to an effect magnitude only. But we cannot exclude that such an interaction with the graviton background would be enough to explain the effect without an attraction of the big bang hypothesis. Comparing the own model predictions with supernova cosmology data by Riess et al [9], the author finds here good accordance between the redshift model and observations.

From another side, it is shown here, that every massive body, with a non-zero velocity v relatively to the isotropic graviton background, should experience a constant acceleration. If one assumes that a full observable redshift magnitude is caused by such a quantum interaction with single gravitons, then this acceleration will have the same order of magnitude as a small additional acceleration of NASA deep-space probes (Pioneer 10/11, Galileo, and Ulysses), about which it was reported by Anderson's team [10].

It is known, that a gravitational interaction between two particles is very weak on big distances. One may expect, that its non-dimensional coupling "constant", which could be an analogue of QED's coupling constant $\alpha \simeq 1/137$, would be proportional to $E_1 E_2 / E_{Pl}^2$, where E_1 and E_2 are energies of particles, $E_{Pl} \simeq 10^{19} GeV$ is the Planck energy (i.e. the mentioned "constant" is a bilinear function of energies of particles). May such an interaction with gravitons decelerate a big cosmic probe or, at the worst, give observable redshifts? We must take into account, that we know little of quan-

tum gravity (see, for example, [11]). Today, there does not exist a complete theory of it. The weak field limit is successfully investigated in the context of linearized gravity [12]. In this approach, one considers gravitons without self-interaction, comparing their energies to the Planck scale. Unified theories, including gravity, contain, as a rule, big spectra of non-observed particles [13, 14].

The Newton gravitational constant G characterizes an interaction on a macro level. But on this level, from a quantum point of view, the interaction may be superstrong. For example, if we consider two stars, having the Sun masses, as "particles", then, for this case, the non-dimensional "constant" will be equal to 10^{72} . Of course, it means only, that one cannot consider an interaction between such "particles" as a result of exchange by single gravitons. Because of self-interaction of gravitons, possible Feynman's diagrams should be complex and should contain a lot of crossing chains of vertexes. Because of it, the Newton constant G may be, perhaps, much smaller than an unknown constant which characterizes a single act of interaction.

All considered effects depend on the equivalent temperature T of the graviton background, which are unknown out of standard cosmological models, based on the big bang hypothesis. But we must take into account, that known estimates of a classical gravitational wave background intensity are consistent with values of this equivalent temperature, which may be not more than few Kelvin degrees [15, 16, 17]. Probably, future gravitational wave detectors (for the low frequencies $\sim 10^{-3}Hz$) will give more exact estimates [18] - [21].

1.2 Photon energy losses due to an interaction with the graviton background

Let us introduce the hypothesis, which is considered here to be independent from the standard cosmological model: there exists the isotropic graviton background. Then photon scattering is possible on gravitons $\gamma + h \rightarrow \gamma + h$, where γ is a photon and h is a graviton, if one of the gravitons is virtual. The energy-momentum conservation law prohibits energy transfer to free gravitons.

Average energy losses of a photon with an energy E on a way dr will be

equal to

$$dE = -aE dr, \quad (1.1)$$

where a is a constant. Here we take into account that a gravitational "charge" of a photon must be proportional to E (it gives the factor E^2 in a cross-section) and a normalization of a photon wave function gives the factor E^{-1} in the cross-section. Also we assume that a photon average energy loss $\bar{\omega}$ in one act of interaction is relatively small to a photon energy E . We must identify $a = H/c$, where c is the light velocity, to have the Hubble law for small distances [22].

A photon energy E should depend on a distance from a source r as

$$E(r) = E_0 \exp(-ar), \quad (1.2)$$

where E_0 is an initial value of energy.

The expression (2) is just only so far as the condition $\bar{\omega} \ll E(r)$ takes place. Photons with a very small energy may lose or acquire an energy changing their direction of propagation after scattering. Early or late such photons should turn out in thermodynamic equilibrium with the graviton background, flowing into their own background. Decay of virtual gravitons should give photon pairs for this background too. Possibly, we know the last one as the cosmic microwave background [23, 24].

It follows from the expression (2) that an exact dependence $r(z)$ is the following one:

$$r(z) = \ln(1+z)/a, \quad (1.3)$$

if an interaction with the graviton background is the only cause of redshifts. We see that this redshift does not depend on a light frequency. For small z , the dependence $r(z)$ will be linear.

The expressions (1) - (3) are the same that appear in other tired-light models (compare with [6]). In our case, they follow from a possible existence of the isotropic graviton background, from quantum electrodynamics, and from the fact that a gravitational "charge" of a photon must be proportional to E .

1.3 An additional relaxation of a photon flux due to non-forehead collisions with gravitons

An interaction of photons with the graviton background will lead to an additional relaxation of a photon flux, caused by transmission of a momentum transversal component to some photons. Photon flux's average energy losses on a way dr should be proportional to $badr$, where b is a constant of the order 1. These losses are connected with a rejection of a part of photons from a source-observer direction. Such the relaxation together with the redshift will give a connection between visible object's diameter and its luminosity (i.e. the ratio of an object visible angular diameter to a square root of visible luminosity), distinguishing from the one of the standard cosmological model.

Let us consider that in a case of a non-forehead collision of a graviton with a photon, the latter leaves a photon flux detected by a remote observer (an assumption of narrow beam of rays). Then we get the following estimate for the factor b :

$$b = 3/2 + 2/\pi = 2,137. \quad (1.4)$$

It is assumed here that a cross-section of interaction is modified by the factor $|\cos \alpha|$ where α is an angle between wave vectors of a photon and of a graviton raiding on it from front or back hemispheres. To average on the angle α , one must take into account a dependence of a graviton flux, which falls on a picked out area (cross-section), on the angle α . Thus in the simplest case of the uniform non-expanding universe with the Euclidean space, we shall have the quantity

$$(1+z)^{(1+b)/2} \equiv (1+z)^{1,57}$$

in a visible object diameter-luminosity connection if whole redshifts would be caused by such an interaction with the background (instead of $(1+z)^2$ for the expanding uniform universe). Of course, this quantity may be modified with evolutionary effects. For near sources, the estimate of the factor b will be an increased one.

1.4 Comparison of the redshift model with supernova cosmology data

In a case of flat no-expanding universe, a photon flux relaxation can be characterized by the factor b , so that the luminosity distance D_L [9] is equal in our model to:

$$D_L = a^{-1} \ln(1+z) \cdot (1+z)^{(1+b)/2} \equiv a^{-1} f_1(z; b), \quad (1.5)$$

where z is a redshift. The theoretical estimate for b is: $b = 3/2 + 2/\pi = 2.137$. Thus, the redshift

$$z = \exp(ar) - 1 \quad (1.6)$$

and the luminosity distance D_L are characterized in the model by two parameters: H and b (r is a geometrical distance). One can introduce an effective Hubble constant

$$H_{eff} \equiv cdz/dr. \quad (1.7)$$

In our model

$$H_{eff} = H \cdot (z + 1); \quad (1.8)$$

in a language of expansion it can be interpreted as "a current deceleration of the expansion".

High- z Supernova Search Team data [9] give us a possibility to evaluate H in our model. Instead of prompt fitting to data, we can use one of the best fits of the function $D_L(z; H_0, \Omega_M, \Omega_\Lambda)$ to supernovae data from [9] (see Eq.2 in [9]) with $\Omega_M = -0.5$ and $\Omega_\Lambda = 0$, which is unphysical in the original work. For $1 - \Omega_M > 0$ and $1 + \Omega_M z > 0$, the function $D_L(z; H_0, \Omega_M, \Omega_\Lambda)$ is equal to (see the integral in [25]):

$$\begin{aligned} D_L &= a^{-1} (1+z) m^{-1} \sinh(\ln |(k-m)/(k+m)| - \ln |(1-m)/(1+m)|) \equiv \\ &\equiv a^{-1} f_2(z; \Omega_M, \Omega_\Lambda), \end{aligned} \quad (1.9)$$

where $m \equiv (1 - \Omega_M)^{1/2}$, $k \equiv (1 + \Omega_M z)^{1/2}$. Assuming $b = 2.137$, we can find H from the connection:

$$HD_L/H_0D_L = f_1(z; b)/f_2(z; \Omega_M, \Omega_\Lambda), \quad (1.10)$$

where H_0 is an estimate of the Hubble constant from [9] (see Table 1). We see that $H/H_0 \simeq const$, a deviation $(H - \langle H \rangle) / \langle H \rangle$ from an average value $\langle H \rangle \simeq 1.09H_0$ is less than $\pm 5\%$.

Table 1.1: Comparison with supernovae data

z	0	0.1	0.2	0.3	0.4	0.5	0.6	0.7	0.8	0.9	1.0
f_1	0	0.110	0.242	0.396	0.570	0.765	0.983	1.222	1.480	1.759	2.058
f_2	0	0.103	0.219	0.359	0.511	0.677	0.863	1.074	1.301	1.565	1.854
H/H_0	-	1.068	1.105	1.103	1.115	1.130	1.139	1.138	1.138	1.124	1.110

It means, that the model is in good accordance with supernovae data. This accordance cannot become worse, if one evaluates both of the parameters fitting our two-parametric function $D_L(z; H, b)$ to supernovae data.

If one would suggest that $f_1(z; b)$ describes results of observations in an expanding universe, one could conclude that it is "an accelerating one". But a true conclusion may be strange: our universe is not expanding, and redshifts have the non-dopplerian nature.

1.5 Other possibilities to verify the conjecture about redshift's local nature

If redshifts of remote objects would be provided by such the local cause as an interaction of photons with the graviton background, then a spectrum of ultrastable laser radiation after a delay line should have a small redshift too. It gives us a hope to carry out a straight verification of the conjecture about redshift's local nature on the Earth after creation of ultrastable lasers with an instability $\sim 10^{-17}$ [26] and of optical delay lines for a delay ~ 10 s [27].

A discrete character of photon energy losses by interaction with gravitons may produce a specific deformation of a spectrum of ultrastable laser radiation in a delay line: a step would appear beside a spectral line, from the side of low frequencies [28]. Such steps would appear beside single narrow spectral lines of remote objects too. A width of the step should linear raise with z . For remote objects, this additional effect would be caused by multifold interactions of a small part of photons with the graviton background. This effect would be observable, if $\bar{\omega}$ will be comparable with a spectral line width, a redshift of which one will measure.

An establishment of a cosmological distance scale, which will be independent of redshifts, would allow to verify the expression (3) or its consequence:

$$r_1/r_2 = \ln(1 + z_1)/\ln(1 + z_2), \quad (1.11)$$

where r_1 and r_2 are the distances to the sources 1 and 2, z_1 and z_2 are their redshifts.

It follows from (6) for small ar that

$$z = ar + (ar)^2/2 + (ar)^3/6 + \dots, \quad (1.12)$$

where $a = H/c$. Estimates of coefficients by r^2, r^3, \dots , which would be received from an analysis of astrophysical data for small z , could be compared with their values from (12) (see [29]). The Canada-France redshift survey [30] may serve as an example of big statistics which could make possible such a comparison.

We can verify a proportionality of the ratio of an object visible angular diameter to a square root of visible luminosity to the quantity $(1+z)^{1.57}$, which takes place in the assumption that the uniform no-expanding universe with the quasi-Euclidean space are realized. We must keep in the mind, that evolutionary effects would change a value of the ratio.

Perspective programs of big statistics accumulation for quasar redshifts on a base of the microlensing effect [31] would be useful to verify the local nature of redshifts, too.

1.6 Deceleration of massive bodies by the graviton background

It was reported by Anderson's team [10], that NASA deep-space probes (Pioneer 10/11, Galileo, and Ulysses) experience a small additional constant acceleration, directed towards the Sun. Today, a possible origin of the effect is unknown. It must be noted here that the reported direction of additional acceleration may be a result of the simplest conjecture, which was accepted by the authors to provide a good fit for all probes. One should compare different conjectures to choose the one giving the best fit.

We consider here a deceleration of massive bodies, which would give a similar deformation of cosmic probes' trajectories. The one would be a result of interaction of a massive body with the graviton background, but such an additional acceleration will be directed against a body velocity.

It follows from an universality of gravitational interaction, that not only photons, but all other objects, moving relatively to the background, should loss their energy too due to such a quantum interaction with gravitons. If

$a = H/c$, it turns out that massive bodies must feel a constant deceleration of the same order of magnitude as a small additional acceleration of cosmic probes.

Let us now denote as E a full energy of a moving body which has a velocity v relatively to the background. Then energy losses of the body by an interaction with the graviton background (due to forehead collisions with gravitons) on the way dr must be expressed by the same formula (1):

$$dE = -aE dr,$$

where $a = H/c$. If $dr = v dt$, where t is a time, and $E = mc^2 / \sqrt{1 - v^2/c^2}$, we get for the body acceleration $w \equiv dv/dt$ by a non-zero velocity:

$$w = -ac^2(1 - v^2/c^2). \quad (1.13)$$

We assume here, that non-forehead collisions with gravitons give only stochastic deviations of a massive body's velocity direction, which are negligible. For small velocities:

$$w \simeq -Hc. \quad (1.14)$$

If the Hubble constant H is equal to $1.6 \cdot 10^{-18} s^{-1}$, the acceleration will be equal to

$$w \simeq -4.8 \cdot 10^{-10} m/s^2, \quad (1.15)$$

that corresponds approximately to one half of the observed additional acceleration for NASA probes.

We must emphasize here that the acceleration w is directed against a body velocity only in a special system of reference (in which the graviton background is isotropic). In other systems of reference, we will find its direction, using transformation formulae for an acceleration (see [29]). We can assume that the graviton background and the microwave one are isotropic in one system of reference (the Earth velocity relatively to the microwave background was determined in [32]).

To verify our conjecture about an origin of probes' additional acceleration, one could re-analyze radio Doppler data for probes. One should find a velocity of the special system of reference and a constant probe acceleration w in this system which must be negative, as it is described above. These two parameters must provide the best fit for all probes, if our conjecture is true. In such a case, one can get an independent estimate of the Hubble constant, based on the measured value of probe's additional acceleration: $H = |w|/c$.

Under influence of such a small additional acceleration w , a probe must move on a deformed trajectory. Its view will be determined by small seeming deviations from exact conservation laws for energy and angular momentum of a not-fully reserved body system which one has in a case of neglecting with the graviton background. For example, Ulysses should go some nearer to the Sun when the one rounds it. It may be interpreted as an additional acceleration, directed towards the Sun, if we shall think that one deals with a reserved body system.

It is very important to understand, why such an acceleration has not been observed for planets. This acceleration will have different directions by motion of a body on a closed orbit. As a result, an orbit should be deformed. Possibly, the general relativity effect of a perihelion revolution [33] would lead to a partial compensation of an average influence of the considered acceleration within a big time. This question needs a further consideration.

1.7 Estimates of a cross-section and of new constants which would characterize an interaction with single gravitons

Let us assume that a full redshift magnitude is caused by an interaction with single gravitons. If $\sigma(E, \omega)$ is a cross-section of interaction by forehead collisions of a photon with an energy E with a graviton, having an energy ω , we consider factually (see (1)), that

$$\frac{d\sigma(E, \omega)}{Ed\Omega} = \text{const}(E),$$

where $d\Omega$ is a space angle element, and the function $\text{const}(x)$ has a constant value for any x . If $f(\omega, T)d\Omega/2\pi$ is a spectral density of graviton flux in the limits of $d\Omega$ in some direction, i.e. an intensity of a graviton flux is equal to an integral $(d\Omega/2\pi) \int_0^\infty f(\omega, T)d\omega$, T is an equivalent temperature of the graviton background, we can write for the Hubble constant $H = ac$, introduced in the expression (1):

$$H = \frac{1}{2\pi} \int_0^\infty \frac{\sigma(E, \omega)}{E} f(\omega, T) d\omega.$$

If $f(\omega, T)$ can be described by the Planck formula for equilibrium radiation, then

$$\int_0^\infty f(\omega, T) d\omega = \sigma T^4,$$

where σ is the Stephan- Boltzmann constant [34]. As carriers of a gravitational "charge" (without consideration of spin properties), gravitons should be described in the same manner as photons (compare with [12]), i.e. one can write for them:

$$\frac{d\sigma(E, \omega)}{\omega d\Omega} = \text{const}(\omega).$$

Now let us introduce a new dimensional constant D so, that for forehead collisions:

$$\sigma(E, \omega) = D \cdot E \cdot \omega.$$

Then

$$H = \frac{1}{2\pi} D \cdot \bar{\omega} \cdot (\sigma T^4), \quad (1.16)$$

where $\bar{\omega}$ is an average graviton energy.²

Assuming $T \sim 3K$, $\bar{\omega} \sim 10^{-4} eV$, and $H = 1.6 \cdot 10^{-18} s^{-1}$, we get the following estimate for D :

$$D \sim 10^{-27} m^2/eV^2,$$

that gives us the phenomenological estimate of cross-section by the same E and $\bar{\omega}$:

$$\sigma(E, \bar{\omega}) \sim 10^{-35} m^2.$$

One can compare this value with the cross-section of quasi-elastic neutrino-electron scattering [35], having, for example, the order $\sim 10^{-44} m^2$ by a neutrino energy about 6 GeV.

Let us introduce new constants: G_0, l_0, E_0 , which are analogues, on this new scale, of classical constants: the Newton constant G , the Planck length l_{Pl} , and the Planck energy E_{Pl} correspondingly. Let

$$D \equiv (l_0/E_0)^2 = (G_0/c^4)^2,$$

where $l_0 = \sqrt{G_0 \hbar / c^3}$, $E_0 = \sqrt{\hbar c^5 / G_0}$. Then we have for these new constants:

$$G_0 \sim 1.6 \cdot 10^{39} m^3/kg \cdot s^2, l_0 \sim 2.4 \cdot 10^{-12} m, E_0 \sim 1.6 \text{ KeV}.$$

²In this version, the remainder of this section is replaced with a corrected fragment

If one would replace G with G_0 , then an electrostatic force, acting between two protons, will be $\sim 2 \cdot 10^{13}$ times smaller than a gravitational one by the same distance.

Using E_0 instead of E_{Pl} , we can evaluate the new non-dimensional "constant" (a bilinear function of E and ω) k , which would characterize one act of interaction: $k \equiv E \cdot \omega / E_0^2$. We must remember here, that an universality of gravitational interaction allows to expect that this floating coupling "constant" k should characterize interactions of any particles with an energy E , including gravitons, with single gravitons. For $E \sim 1eV$ and $\omega \sim 10^{-4}eV$, we have $k \sim 4 \cdot 10^{-9}$. But for $E \sim 25MeV$ and $\omega \sim 10^{-3}eV$, we shall have $k \sim 10^{-2}$, i.e. k will be comparable with QED's constant α . Already by $E \sim \omega \sim 5KeV$, such an interaction would have the same intensity as a strong interaction ($k \sim 10$).

1.8 Conclusion

Independently from the described conjecture, we would wait that a straight verification of redshift's nature on the Earth should be one of main works for coming ultrastable lasers. In a case of the dopplerian nature of redshifts, one will get a negative result for a laser beam frequency shift after a delay line. Such a negative result would be an important indirect experimental confirmation of the big bang hypothesis. Today for most people, a positive result seems to be impossible. But in a case of such an unexpected positive result, the redshift laser experiment would be a key one for cosmology.

One can wait that unification of gravity with physics of particles will need non-ordinary solutions, for example, introduction of many-dimensional spaces, in which a model of gravity has the basic symmetries of the Standard Model [36]. From another side, the author feels a necessity to include gravity in the model of composite fermions to describe a set of generations and to solve a problem of particle masses [37].

If further investigations display that an anomalous NASA probes' acceleration cannot be explained by some technical causes, left out of account today, it will give a big push to a further development of physics of particles. Both supernova cosmology data and the Anderson's team discovery may change a gravity position in a hierarchy of known interactions, and, possibly, give us a new chance to unify their description.

This paper earlier version's one-page abstract was poster presented at the

18 *CHAPTER 1. MANIFESTATIONS OF THE GRAVITON BACKGROUND*

Particles and Nuclei International Conference (PANIC'99), June 10-16, 1999,
Uppsala, Sweden.

Библиотека БГУИР

Bibliography

- [1] Weinberg, S. Gravitation and Cosmology. John Wiley and Sons, 1972.
- [2] Linde, A.D. Usp. Phiz. Nauk, 1984, v.144, p.177.
- [3] Vaucouleurs, G. De. ApJ, 1970, v.159, p.435.
- [4] Bergh, S. van der. Nature, 1970, v.225, p.503.
- [5] Zwicky, F. Proc. Nat. Acad. Sci., 1929, v.15, p.773.
- [6] LaViolette, P.A. ApJ, 1986, v.301, p.544.
- [7] Pahre, M.A. et al. ApJ (Letters), 1996, v.456, p.L79.
- [8] Phillips, S. Ap Letters, 1982, v.22, no.4, p.153.
- [9] Riess, A.G., et al, AJ, 1998, v.116, p.1009.
- [10] Anderson, J.D. et al. Phys. Rev. Lett., 1998, v.81, p. 2858.
- [11] Canonical gravity - from classical to quantum. Eds. Ehlers, J., and Fridrich, H. Berlin, 1994.
- [12] Choi, S.Y. et al. Phys. Rev. D, 1993, v.48, p.2953; v.48, p.R5465; 1995, v.51, p.2751.
- [13] Nieuwenhuizen, van P. Phys. Rep., 1981, v.68, p.189.
- [14] Green, M.B., Schwarz, J.H., Witten, E. Superstring Theory. Cambridge University Press, Cambridge, England, 1987.
- [15] Mauceli, E. et al. Phys. Rev. D, 1996, v.54, p.1264.

- [16] Vinet, J.-Y. Phys. Rev. D, 1996, v.54, p.1276.
- [17] McHugh, M.P. et al. Phys. Rev. D, 1996, v.54, p.5991.
- [18] Bradaschia, C. et al. Nucl. Instrum. Methods, 1990, v.A289, p.518.
- [19] Abramovici, A. et al. Science, 1992, v.256, p.325.
- [20] Danzmann, K. et al. Internal Report MPQ, 1994, v.190.
- [21] Tinto, M. Phys. Rev. D, 1996, v.53, p.5354.
- [22] Hubble, E.P., and Humason. ApJ, 1931, v.74, p.43.
- [23] Penzias, A.A., Wilson, R.W. ApJ, 1965, v.142, p.419.
- [24] Smoot, G.F. ApJ (Letters), 1992, v.396, p. L1.
- [25] Dwight, H.B. Tables of Integrals and Other Mathematical Data. New York, The Macmillan Company, 1961.
- [26] Dehmelt, H., and Nagorney, W. Proc. Nat. Acad. Sci. USA, 1988, v.85, p.7426.
- [27] Ivanov, M.A. Quantum Electronics and Laser Science Conference (QELS'95), May 21-26, 1995, Baltimore, USA; paper number: QThG1.
- [28] Ivanov, M.A. European Quantum Electronics Conference (EQEC'96), Sept. 8 - 13, 1996, Hamburg, Germany; paper number: QWD1.
- [29] Tolman, R.C. Relativity, Thermodynamics and Cosmology. Oxford, Clarendon Press, 1969.
- [30] Crampton, D. et al. ApJ, 1995, v.455, p.96.
- [31] Gould, A. ApJ, 1995, v.455, p.37.
- [32] Conklin, E.K. Nature, 1969, v.222, p.971.
- [33] Misner, C.W., Thorne, K.S., Wheeler, J.A. Gravitation. Freeman, San-Francisco, 1973.
- [34] Savel'ev, I.V. Course of General Physics. Moscow, Nauka, 1987.

- [35] Okun, L.B. Leptons and quarks. Moscow, Nauka, 1989, p.155.
- [36] Ivanov, M.A. General Relativity and Gravitation, 1999, v.31, p.1431.
- [37] Ivanov, M.A. Nuovo Cimento, 1992, v.105A, p.77.

Библиотека БГУИР

Chapter 2

Model of graviton-dusty universe

1

Primary features of a new cosmological model, which is based on conjectures about an existence of the graviton background and superstrong gravitational quantum interaction, are considered. These conjectures would be enough to explain redshifts of remote objects, observed dimming of supernovae Ia and deceleration of the NASA deep space probes Pioneer 10, 11 from one point of view. An expansion of the universe is impossible in such the model because of deceleration of massive objects by the graviton background, which is similar to the one for the NASA probes. Redshifts of remote objects are caused in the model by interaction of photons with the graviton background, and the Hubble constant depends on an intensity of interaction and an equivalent temperature of the graviton background. Virtual massive gravitons would be dark matter particles. They transfer energy, lost by luminous matter radiation, which in a final stage may be collected with black holes and other massive objects.

PACS 04.60.-m, 98.80.-k

¹Contribution to the 15th SIGRAV Conference on General Relativity and Gravitational Physics, September 9-12, 2002, Rome, Italy. [arXiv:gr-qc/0107047v3]

2.1 Introduction

In present cosmological models, based on the big bang conjecture, redshifts of remote objects are explained as the Doppler effect. Observation of small additional acceleration of NASA deep space probes [1, 2, 3] may be interpreted in such a manner, that redshifts of galaxies turn out a quantum gravity effect. As well as probes' acceleration, it would be caused by a hypothetical superstrong gravitational quantum interaction with the graviton background [4]. This new hypothesis about the redshift nature finds further confirmation in confrontation [5] with Supernova Search Team data [6].

In this paper, some features of the cosmological model, which may be constructed on a base of such a new approach, are discussed. They are: the redshift nature; a transfer of energy, which is lost by luminous matter radiation, with virtual massive gravitons; an increment of lifetime of such gravitons due to sequent decreasing their energy by collisions with gravitons of the background; final utilization of virtual massive gravitons in black holes and other massive objects.

2.2 Hypothetical superstrong gravitational quantum interaction and its consequences

If the graviton background exists with the equivalent temperature upwards $3K$, then collisions of photons with gravitons of this background will lead to photon redshifts if the interaction is strong enough. A photon energy $E(r)$ will change with increasing of a distance r from a source as

$$E(r) = E_0 \exp(-ar), \quad (2.1)$$

where E_0 is an initial value of energy, $a = H/c$, H is the Hubble constant.

It is shown in author's paper [4], that a cross-section $\sigma(E, \omega)$ of interaction of a photon with an energy E with a graviton, having an energy ω , as well as the Hubble constant H may be expressed with the help of a new dimensional constant D :

$$\sigma(E, \omega) = D \cdot E \cdot \omega, \quad (2.2)$$

$$H = \frac{1}{2\pi} D \cdot \bar{\omega} \cdot (\sigma T^4), \quad (2.3)$$

where $\bar{\omega}$ is an average graviton energy, σ is the Stephan-Boltzmann constant, with $D \sim 10^{-27} m^2/eV^2$ if whole redshift is caused by such the interaction.

An universality of gravitational interaction means that any massive body, moving relatively to the background with a velocity v , must feel a deceleration w , which is equal to:

$$w = -Hc(1 - v^2/c^2). \quad (2.4)$$

For $Hc = (4.8 - 7.2) \cdot 10^{-10} m/s^2$ by $H = (1.6 - 2.4) \cdot 10^{-18} s^{-1}$ (i.e. by $H = (50 - 75) km \cdot s^{-1} \cdot Mpc^{-1}$), a magnitude of this deceleration corresponds to the one of observed additional acceleration for Pioneer 10 [1, 2, 3]. The acceleration w should be directed against a body velocity relatively to the graviton background. The refined data [2] show annual periodic variations of the apparent acceleration. Perhaps, such the variations are connected with Earth's additional acceleration under its orbital motion due to the same interaction with the graviton background [5].

If redshifts of galaxies are really caused by such the effect, then an expected picture of visible Universe changes. A region of the Universe, which is visible by an observer, will not be bounded with a sphere of the Hubble radius $R_0 = c/H$, but any source with a temperature T_s may be picked out by an observer above the microwave background on the distance

$$R < R_0 \ln \frac{T_s}{T}, \quad (2.5)$$

i.e. for a source with $T_s \simeq 6000K$ we have $R < 7.6R_0$. It is $R < (100 - 150)$ Gyr for $R_0 \simeq (13.5 - 20)$ Gyr. An estimate of distances to objects with given z is changed too; for example, the quasar with $z = 5.8$ [7] should be in a distance approximately twice bigger than the one expected in the model based on the Doppler effect.

2.3 Utilization of energy, which is lost by visible matter radiation

Unlike models of expanding universe, in any tired light model one has a problem of utilization of energy, lost by radiation of remote objects. In the model, a virtual graviton forms under collision of a photon with a graviton of the graviton background. It should be massive if an initial graviton transfers its total momentum to a photon; it follows from the energy conservation law that its energy ω' must be equal to 2ω if ω is an initial graviton energy. In force of the uncertainty relation, one has for a virtual graviton lifetime

$\tau : \tau \leq \frac{\hbar}{\omega}$, i.e. for $\omega' \sim 10^{-4}eV$ it is $\tau \leq 10^{-11}s$. In force of conservation laws for energy, momentum and angular momentum, a virtual graviton may decay into no less than three real gravitons. In a case of decay into three gravitons, its energies should be equal to $\omega, \omega'', \omega'''$, with $\omega'' + \omega''' = \omega$. So, after this decay, two new gravitons with $\omega'', \omega''' < \omega$ inflow into the graviton background. It is a source of adjunction of the graviton background.

From another side, an interaction of gravitons of the background between themselves should lead to the formation of virtual massive gravitons too, with energies less than ω_{min} where ω_{min} is a minimal energy of one graviton of an initial interacting pair. If gravitons with energies ω'', ω''' wear out a file of collisions with gravitons of the background, its lifetime has increased. In every such a cycle collision-decay, an average energy of "redundant" gravitons will double decrease, and its lifetime will double increase. Only for ~ 93 cycles, a lifetime will have increased from $10^{-11}s$ to 10 Gyr. Such virtual massive gravitons, with a lifetime increasing from one collision to another, would duly serve dark matter particles. Having a zero (or near to zero) initial velocity relatively to the graviton background, the ones will not interact with matter in any manner except usual gravitation. An ultracold gas of such gravitons will condense under influence of gravitational attraction into black holes or other massive objects. Additionally to it, even in absence of initial heterogeneity, the one will easily arise in such the gas that would lead to arising of super compact massive objects, which will be able to turn out "germs" of black holes. It is a method "to cold" the graviton background.

So, the graviton background may turn up "a perpetual engine" of the Universe, pumping energy from radiation to massive objects. An equilibrium state of the background will be ensured by such the temperature T , for which an energy profit of the background due to an influx of energy from radiation will be equal to a loss of its energy due to a catch of virtual massive gravitons with black holes or other massive objects. In such the picture, the chances are that black holes should turn out "germs" of galaxies. After accumulation of big enough energy by a black hole (to be more exact, by a super compact massive object) by means of a catch of virtual massive gravitons, the one must be absolved from an energy excess in via ejection of matter, from which stars of galaxy should form. It awaits to understand else in such the model how usual matter particles form from virtual massive gravitons. It is optimistic that the model of two-component fundamental fermions by the author [8] owns all symmetries of the standard model of elementary particles (on global level). Perhaps, virtual gravitons with very small masses are fully

acceptable to the role of components of such the system. Observation of non-zero neutrino mass [9] increases chances of this model of the fundamental fermions since there is an additional right singlet in the model, which is able to provide a non-zero neutrino mass. Chances of the model will rise still more, if any particle of the forth generation or some indirect indication of its existence will be detected. In author's paper [10], the model of gravity in flat 12-space was described with global $U(1)$ -symmetry, in which a possibility exists to introduce $SU(2)$ -symmetry. I hope that unification of these models may give us a clue to hidden still unity of gravity and other known interactions.

2.4 Conclusion

Observations of last years give us strong evidences for supermassive black holes in active and normal galactic nuclei [11, 12, 13, 14, 15] (of course, a central dark mass in galactic nucleus may not be a black hole, but it is most likely to the one by its properties from all known objects; one must remember that we know only that these objects are supermassive and compact). The available evidence is consistent with a suggestion that a majority of galaxies has black holes [11, 16]. The discovery by Gebhardt et al. [17] and Ferrarese and Merritt [18] of a correlation between nuclear black hole mass and stellar velocity dispersion in elliptical galaxies and spiral bulges shows that black holes are "native" for host galaxies. Massive nuclear black holes of $10^6 - 10^9$ solar masses may be responsible for the energy production in quasars and active galaxies [11]. Doppler-shifted emission lines in the spectrum of active galactic nuclei are likely to originate from relativistic outflows (or jets) in the vicinity of the central black hole [19]. Black hole candidates are also known in binaries, supernovae, and clusters.

In a frame of the model [20] it was suggested that central black holes of early-type galaxies grew adiabatically in homogeneous isothermal cores due to matter accretion. In the present model, a role of black holes in evolution of the Universe is changed; the ones may be collectors of virtual massive gravitons and "germs" of galaxies. Additionally, the growth of black hole mass inside of future supernova stars would lead to their instability and formation of supernovae.

In author's papers [21, 22, 4], the methods were considered how to verify the conjecture about the described non-dopplerian nature of redshifts. One

of them is a ground-based experiment with a superstable laser radiation: if the conjecture is true, then a laser radiation frequency after a delay line should be red shifted too. I believe, that creation of necessary superstable lasers with instability $\sim 10^{-17}$ would be speeded up after perception by the scientific community of importance of such the verification.

Библиотека БГУИР

Bibliography

- [1] Anderson, J.D. et al. Phys. Rev. Lett., 1998, v.81, p. 2858.
- [2] S.G.Turyshev et al. XXXIV-th Rencontres de Moriond Meeting on Gravitational Waves and Experimental Gravity. Les Arcs, Savoie, France (January 23-30, 1999). [gr-qc/9903024 v2]
- [3] Anderson, J.D. et al. Phys. Rev. **D65** (2002) 082004. [gr-qc/0104064 v4]
- [4] M.A.Ivanov, General Relativity and Gravitation, **33**, 479 (2001). [Correction of ERRATA: astro-ph/0005084 v2] (see Chapter 1).
- [5] M.A.Ivanov, [gr-qc/0009043]; Proc. of the Int. Symp. "Frontiers of Fundamental Physics 4" (9-13 Dec 2000, Hyderabad, India), Eds B.G. Sidharth and M.V. Altaisky, Kluwer Academic/Plenum Publishers, August 2001; Proc. of the 4th Edoardo Amaldi Conference on Gravitational Waves (Perth, Western Australia, 8-13 July 2001) Class. Quantum Grav. **19**, 1351 (2002).
- [6] A.G. Riess et al. AJ **116**, 1009 (1998).
- [7] X. Fan et al. AJ **120**, 1167 (2000).
- [8] M.A. Ivanov, Nuovo Cimento, **105A**, 77 (1992).
- [9] Y.Fukuda et al. Phys. Rev. Lett, **81**, 1562 (1998).
- [10] M.A.Ivanov, General Relativity and Gravitation, **31**, 1431 (1999).

- [11] R. P. van der Marel, 'New Light on Galaxy Evolution', Proc. IAU Symp. 171, Heidelberg, June 1995, R. Bender and R.L. Davies, eds., Kluwer Academic Publishers.
- [12] G. A. V. Kleijn et al. *AJ*, **120**, 1221 (2000).
- [13] B. M. Peterson and A. Wandel, *ApJ*, **540**, L13, (2000).
- [14] T. Di Matteo, C. L. Carilli and A. C. Fabian, *ApJ*, **547**, 731 (2001).
- [15] Kenji Bekki, *ApJ*, **540**, L79 (2000).
- [16] R. P. van der Marel, 'Galaxy Interactions at Low and High Redshift', Proc. IAU Symposium 186, Kyoto, August 1997, D. B. Sanders and J. Barnes, eds., Kluwer Academic Publ.
- [17] Karl Gebhardt et al. *ApJ*, **539**, L13 (2000).
- [18] L. Ferrarese and D. Merritt, *ApJ*, **539**, L9 (2000).
- [19] Jian-Min Wang et al, *ApJ*, **544**, 381 (2000).
- [20] R. P. van der Marel, *AJ*, **117**, 744 (1998).
- [21] M.A. Ivanov, Quantum Electronics and Laser Science Conference (QELS'95), May 21-26, 1995, Baltimore, USA; paper number: QThG1.
- [22] M.A. Ivanov, European Quantum Electronics Conference (EQEC'96), Sept. 8 - 13, 1996, Hamburg, Germany; paper number: QWD1.

Chapter 3

Screening the graviton background, graviton pairing, and Newtonian gravity

1

It is shown that screening the background of super-strong interacting gravitons creates for any pair of bodies as an attraction force as well an repulsion force due to pressure of gravitons. For single gravitons, these forces are approximately balanced, but each of them is much bigger than a force of Newtonian attraction. If single gravitons are pairing, a body attraction force due to pressure of such graviton pairs is twice exceeding a corresponding repulsion force under the condition that graviton pairs are destructed by collisions with a body. If the considered quantum mechanism of classical gravity is realized in the nature, then an existence of black holes contradicts to Einstein's equivalence principle. In such the model, Newton's constant is proportional to H^2/T^4 , where H is the Hubble constant, T is an equivalent temperature of the graviton background. The estimate of the Hubble constant is obtained $H = 2.14 \cdot 10^{-18} \text{ s}^{-1}$ (or $66.875 \text{ km} \cdot \text{s}^{-1} \cdot \text{Mpc}^{-1}$).

PACS 04.60.-m, 98.70.Vc

¹[arXiv:gr-qc/0207006v3]

3.1 Introduction

It was shown by the author in the previous study [1, 2] that an alternative explanation of cosmological redshift as a result of interaction of a photon with the graviton background is possible. In the case, observed dimming of supernovae Ia [3] and the Pioneer 10 anomaly [4] may be explained from one point of view as additional manifestations of interaction with the graviton background. Some primary features of a new cosmological model, based on this approach, are described in author's preprint [5].

In this paper, forces of gravitonic radiation pressure are considered which act on bodies in a presence of such the background. It is shown that pressure of single gravitons of the background, which run against a body pair from infinity, results in mutual attraction of bodies with a magnitude which should be approximately 1000 times greater than Newtonian attraction. But pressure of gravitons scattered by bodies gives a repulsion force of the same order; the last is almost exact compensating this attraction. To get Newton's law of gravity, it is necessary to assume that gravitons form correlated pairs. By collision with a body, such a pair should destruct in single gravitons. Flying away gravitons of a pair should happen in independent directions, that decreases a full cross-section of interaction with scattered gravitons. As a result, an attraction force will exceed a corresponding repulsion force acting between bodies. In such the model, Newton's constant is connected with the Hubble constant that gives a possibility to obtain a theoretical estimate of the last. We deal here with a flat non-expanding universe fulfilled with superstrong interacting gravitons; it changes the meaning of the Hubble constant which describes magnitude of three small effects of quantum gravity but not any expansion.

The considered fine quantum mechanism of classical gravity differs from a generally admitted one. In the full analogy with quantum electrodynamics, it had been shown already in the first works in quantum gravity [6, 7] that Newton's law may be explained as a result of exchange with virtual longitudinal gravitons, sources of which are attracting bodies.

A conjecture about a composite nature of gravitons was considered by few authors with other reasons (see short remarks and further references in [8], and also the papers [9, 10]). The main idea of works [11, 12]), where composite gravitons were considered as correlated pairs of photons, seems to be the most interesting for the author.

3.2 Screening the graviton background

In author's papers [1, 2], a cross-section $\sigma(E, \epsilon)$ of interaction of a graviton with an energy ϵ with any body having an energy E was accepted to be equal to:

$$\sigma(E, \epsilon) = D \cdot E \cdot \epsilon, \quad (3.1)$$

where D is some new dimensional constant. The Hubble constant H should be proportional to D :

$$H = \frac{1}{2\pi} D \cdot \bar{\epsilon} \cdot (\sigma T^4), \quad (3.2)$$

where $\bar{\epsilon}$ is an average graviton energy, σ is the Stephan-Boltzmann constant, T is an effective temperature of the graviton background. The interaction should be super-strong to cause the whole redshift magnitude - it is necessary to have $D \sim 10^{-27} m^2/eV^2$.

If gravitons of the background run against a pair of bodies with masses m_1 and m_2 (and energies E_1 and E_2) from infinity, then a part of gravitons is screened. Let $\sigma(E_1, \epsilon)$ is a cross-section of interaction of body 1 with a graviton with an energy $\epsilon = \hbar\omega$, where ω is a graviton frequency, $\sigma(E_2, \epsilon)$ is the same cross-section for body 2. In absence of body 2, a whole modulus of a gravitonic pressure force acting on body 1 would be equal to:

$$4\sigma(E_1, \langle \epsilon \rangle) \cdot \frac{1}{3} \cdot \frac{4f(\omega, T)}{c}, \quad (3.3)$$

where $f(\omega, T)$ is a graviton spectrum with a temperature T (assuming to be planckian), the factor 4 in front of $\sigma(E_1, \langle \epsilon \rangle)$ is introduced to allow all possible directions of graviton running, $\langle \epsilon \rangle$ is another average energy of running gravitons with a frequency ω taking into account a probability of that in a realization of flat wave a number of gravitons may be equal to zero, and that not all of gravitons ride at a body.

Body 2, placed on a distance r from body 1, will screen a portion of running against body 1 gravitons which is equal for big distances between the bodies (i.e. by $\sigma(E_2, \langle \epsilon \rangle) \ll 4\pi r^2$):

$$\frac{\sigma(E_2, \langle \epsilon \rangle)}{4\pi r^2}. \quad (3.4)$$

Taking into account all frequencies ω , an attractive force will act between bodies 1 and 2 :

$$F_1 = \int_0^\infty \frac{\sigma(E_2, \langle \epsilon \rangle)}{4\pi r^2} \cdot 4\sigma(E_1, \langle \epsilon \rangle) \cdot \frac{1}{3} \cdot \frac{4f(\omega, T)}{c} d\omega. \quad (3.5)$$

Let $f(\omega, T)$ is described with the Planck formula:

$$f(\omega, T) = \frac{\omega^2}{4\pi^2 c^2} \frac{\hbar\omega}{\exp(\hbar\omega/kT) - 1}. \quad (3.6)$$

Let $x \equiv \hbar\omega/kT$, and $\bar{n} \equiv 1/(\exp(x) - 1)$ is an average number of gravitons in a flat wave with a frequency ω (on one mode of two distinguishing with a projection of particle spin). Let $P(n, x)$ is a probability of that in a realization of flat wave a number of gravitons is equal to n , for example $P(0, x) = \exp(-\bar{n})$.

A quantity $\langle \epsilon \rangle$ must contain the factor $(1 - P(0, x))$, i.e. it should be:

$$\langle \epsilon \rangle \sim \hbar\omega(1 - P(0, x)), \quad (3.7)$$

that let us to reject flat wave realizations with zero number of gravitons.

But attempting to define other factors in $\langle \epsilon \rangle$, we find the difficult place in our reasoning. On this stage, it is necessary to introduce some new assumption to find the factors. Perhaps, this assumption will be well-founded in a future theory - or would be rejected. If a flat wave realization, running against a finite size body from infinity, contains one graviton, then one cannot consider that it must stringent ride at a body to interact with some probability with the one. It would break the uncertainty principle by W. Heisenberg. We should admit that we know a graviton trajectory. The same is pertaining to gravitons scattered by one of bodies by big distances between bodies. What is a probability that a single graviton will ride namely at the body? If one denotes this probability as P_1 , then for a wave with n gravitons their chances to ride at the body must be equal to $n \cdot P_1$. Taking into account the probabilities of values of n for the Poisson flux of events, an additional factor in $\langle \epsilon \rangle$ should be equal to $\bar{n} \cdot P_1$. I admit here that

$$P_1 = P(1, x), \quad (3.8)$$

where $P(1, x) = \bar{n} \exp(-\bar{n})$; (below it is admitted for pairing gravitons: $P_1 = P(1, 2x)$ - see section 4).

In such the case, we have for $\langle \epsilon \rangle$ the following expression:

$$\langle \epsilon \rangle = \hbar\omega(1 - P(0, x))\bar{n}^2 \exp(-\bar{n}). \quad (3.9)$$

Then we get for an attraction force F_1 :

$$F_1 = \frac{4}{3} \frac{D^2 E_1 E_2}{\pi r^2 c} \int_0^\infty \frac{\hbar^3 \omega^5}{4\pi^2 c^2} (1 - P(0, x))^2 \bar{n}^5 \exp(-2\bar{n}) d\omega = \quad (3.10)$$

$$\frac{1}{3} \cdot \frac{D^2 c (kT)^6 m_1 m_2}{\pi^3 \hbar^3 r^2} \cdot I_1,$$

where

$$I_1 \equiv \int_0^\infty x^5 (1 - \exp(-(\exp(x) - 1)^{-1}))^2 (\exp(x) - 1)^{-5} \exp(-2(\exp(x) - 1)^{-1}) dx = 5.636 \cdot 10^{-3}. \quad (3.11)$$

If $F_1 \equiv G_1 \cdot m_1 m_2 / r^2$, then the constant G_1 is equal to:

$$G_1 \equiv \frac{1}{3} \cdot \frac{D^2 c (kT)^6}{\pi^3 \hbar^3} \cdot I_1. \quad (3.12)$$

By $T = 2.7K$:

$$G_1 = 1215.4 \cdot G, \quad (3.13)$$

that is three order greater than Newton's constant G .

But if gravitons are elastic scattered with body 1, then our reasoning may be reversed: the same portion (4) of scattered gravitons will create a repulsive force F'_1 acting on body 2 and equal to

$$F'_1 = F_1, \quad (3.14)$$

if one neglects with small allowances which are proportional to D^3/r^4 . The last ones are caused by decreasing of gravitonic flux running against body 1 due to screening by body 2 (see section 5).

So, for bodies which elastic scatter gravitons, screening a flux of single gravitons does not ensure Newtonian attraction. But for gravitonic black holes which absorb any particles and do not re-emit them (by the meaning of a concept, the ones are usual black holes; I introduce a redundant adjective only from a caution), we will have $F'_1 = 0$. It means that such the object would attract other bodies with a force which is proportional to G_1 but not to G , i.e. Einstein's equivalence principle would be violated for it. This conclusion, as we shall see below, stays in force for the case of graviton pairing too. The conclusion cannot be changed with taking into account of Hawking's quantum effect of evaporation of black holes [13].

3.3 Graviton pairing

To ensure an attractive force which is not equal to a repulsive one, particle correlations should differ for *in* and *out* flux. For example, single gravitons of

running flux may associate in pairs. If such pairs are destructed by collision with a body, then quantities $\langle \epsilon \rangle$ will distinguish for running and scattered particles. Graviton pairing may be caused with graviton's own gravitational attraction or gravitonic spin-spin interaction. Left an analysis of the nature of graviton pairing for the future; let us see that gives such the pairing.

To find an average number of pairs \bar{n}_2 in a wave with a frequency ω for the state of thermodynamic equilibrium, one may replace $\hbar \rightarrow 2\hbar$ by deducing the Planck formula. Then an average number of pairs will be equal to:

$$\bar{n}_2 = \frac{1}{\exp(2x) - 1}, \quad (3.15)$$

and an energy of one pair will be equal to $2\hbar\omega$. It is important that graviton pairing does not change a number of stationary waves, so as pairs nucleate from existing gravitons. The question arises: how many different modes, i.e. spin projections, may have graviton pairs? We consider that the background of initial gravitons consists two modes. For massless transverse bosons, it takes place as by spin 1 as by spin 2. If graviton pairs have maximum spin 2, then single gravitons should have spin 1. But from such particles one may constitute four combinations: $\uparrow\uparrow$, $\downarrow\downarrow$ (with total spin 2), and $\uparrow\downarrow$, $\downarrow\uparrow$ (with total spin 0). All these four combinations will be equiprobable if spin projections \uparrow and \downarrow are equiprobable in a flat wave (without taking into account a probable spin-spin interaction).

But it is happened that, if expression (15) is true, it follows from the energy conservation law that composite gravitons should be distributed only in two modes. So as

$$\lim_{x \rightarrow 0} \frac{\bar{n}_2}{\bar{n}} = 1/2, \quad (3.16)$$

then by $x \rightarrow 0$ we have $2\bar{n}_2 = \bar{n}$, i.e. all of gravitons are pairing by low frequencies. An average energy on every mode of pairing gravitons is equal to $2\hbar\omega\bar{n}_2$, the one on every mode of single gravitons - $\hbar\omega\bar{n}$. These energies are equal by $x \rightarrow 0$, because of it, the numbers of modes are equal too, if the background is in thermodynamic equilibrium with surrounding bodies.

The above reasoning does not allow to choose a spin value 2 or 0 for composite gravitons. A choice of namely spin 2 would ensure the following proposition: all of gravitons in one realization of flat wave have the same spin projections. From another side, a spin-spin interaction would cause it.

The spectrum of composite gravitons is proportional to the Planck one;

it has the view:

$$f_2(2\omega, T)d\omega = \frac{\omega^2}{4\pi^2c^2} \cdot \frac{2\hbar\omega}{\exp(2x) - 1} d\omega \equiv \frac{(2\omega)^2}{32\pi^2c^2} \cdot \frac{2\hbar\omega}{\exp(2x) - 1} d(2\omega). \quad (3.17)$$

It means that an absolute luminosity for the sub-system of composite gravitons is equal to:

$$\int_0^\infty f_2(2\omega, T)d(2\omega) = \frac{1}{8}\sigma T^4, \quad (3.18)$$

where σ is the Stephan-Boltzmann constant; i.e. an equivalent temperature of this sub-system is

$$T_2 \equiv (1/8)^{1/4}T = \frac{2^{1/4}}{2}T = 0.5946T. \quad (3.19)$$

It is important that the graviton pairing effect does not change computed values of the Hubble constant and of anomalous deceleration of massive bodies [1]: twice decreasing of a sub-system particle number due to the pairing effect is compensated with twice increasing the cross-section of interaction of a photon or any body with such the composite gravitons. Non-pairing gravitons with spin 1 give also its contribution in values of redshifts, an additional relaxation of light intensity due to non-forehead collisions with gravitons, and anomalous deceleration of massive bodies moving relative to the background [1, 2].

3.4 Computation of Newton's constant

If running graviton pairs ensure for two bodies an attractive force F_2 , then a repulsive force due to re-emission of gravitons of a pair alone will be equal to $F'_2 = F_2/2$. It follows from that the cross-section for *single additional scattered* gravitons of destructed pairs will be twice smaller than for pairs themselves (the leading factor $2\hbar\omega$ for pairs should be replaced with $\hbar\omega$ for single gravitons). For pairs, we introduce here the cross-section $\sigma(E_2, < \epsilon_2 >)$, where $< \epsilon_2 >$ is an average pair energy with taking into account a probability of that in a realization of flat wave a number of graviton pairs may be equal to zero, and that not all of graviton pairs ride at a body ($< \epsilon_2 >$ is an analog of $< \epsilon >$). This equality is true in neglecting with small allowances which are proportional to D^3/r^4 (see section 5). Replacing

$\bar{n} \rightarrow \bar{n}_2$, $\hbar\omega \rightarrow 2\hbar\omega$, and $P(n, x) \rightarrow P(n, 2x)$, where $P(0, 2x) = \exp(-\bar{n}_2)$, we get for graviton pairs:

$$\langle \epsilon_2 \rangle \sim 2\hbar\omega(1 - P(0, 2x))\bar{n}_2^2 \exp(-\bar{n}_2). \quad (3.20)$$

This expression does not take into account only that beside pairs there may be single gravitons in a realization of flat wave. To reject cases when, instead of a pair, a single graviton runs against a body (a contribution of such gravitons in attraction and repulsion is the same), we add the factor $P(0, x)$ into $\langle \epsilon_2 \rangle$:

$$\langle \epsilon_2 \rangle = 2\hbar\omega(1 - P(0, 2x))\bar{n}_2^2 \exp(-\bar{n}_2) \cdot P(0, x). \quad (3.21)$$

Then a force of attraction of two bodies due to pressure of graviton pairs F_2 - in the full analogy with (5) - will be equal to ²:

$$F_2 = \int_0^\infty \frac{\sigma(E_2, \langle \epsilon_2 \rangle)}{4\pi r^2} \cdot 4\sigma(E_1, \langle \epsilon_2 \rangle) \cdot \frac{1}{3} \cdot \frac{4f_2(2\omega, T)}{c} d\omega = \quad (3.22)$$

$$\frac{8}{3} \cdot \frac{D^2 c (kT)^6 m_1 m_2}{\pi^3 \hbar^3 r^2} \cdot I_2,$$

where

$$I_2 \equiv \int_0^\infty \frac{x^5 (1 - \exp(-(\exp(2x) - 1)^{-1}))^2 (\exp(2x) - 1)^{-5}}{\exp(2(\exp(2x) - 1)^{-1}) \exp(2(\exp(x) - 1)^{-1})} dx = \quad (3.23)$$

$$2.3184 \cdot 10^{-6}.$$

The difference F between attractive and repulsive forces will be equal to:

$$F \equiv F_2 - F'_2 = \frac{1}{2} F_2 \equiv G_2 \frac{m_1 m_2}{r^2}, \quad (3.24)$$

where the constant G_2 is equal to:

$$G_2 \equiv \frac{4}{3} \cdot \frac{D^2 c (kT)^6}{\pi^3 \hbar^3} \cdot I_2. \quad (3.25)$$

As G_1 as well G_2 are proportional to T^6 (and $H \sim T^5$, so as $\bar{\epsilon} \sim T$).

²In initial version of this paper, factor 2 was lost in the right part of Eq. (22), and the theoretical values of D and H were overestimated of $\sqrt{2}$ times

If one assumes that $G_2 = G$, then it follows from (25) that by $T = 2.7K$ the constant D should have the value:

$$D = 0.795 \cdot 10^{-27} m^2/eV^2. \quad (3.26)$$

An average graviton energy of the background is equal to:

$$\bar{\epsilon} \equiv \int_0^\infty \hbar\omega \cdot \frac{f(\omega, T)}{\sigma T^4} d\omega = \frac{15}{\pi^4} I_4 kT, \quad (3.27)$$

where

$$I_4 \equiv \int_0^\infty \frac{x^4 dx}{\exp(x) - 1} = 24.866$$

(it is $\bar{\epsilon} = 8.98 \cdot 10^{-4} eV$ by $T = 2.7K$).

We can use (2) and (25) to establish a connection between the two fundamental constants G and H under the condition that $G_2 = G$. We have for D :

$$D = \frac{2\pi H}{\bar{\epsilon}\sigma T^4} = \frac{2\pi^5 H}{15k\sigma T^5 I_4}; \quad (3.28)$$

then

$$G = G_2 = \frac{4}{3} \cdot \frac{D^2 c (kT)^6}{\pi^3 \hbar^3} \cdot I_2 = \frac{64\pi^5}{45} \cdot \frac{H^2 c^3 I_2}{\sigma T^4 I_4^2}. \quad (3.29)$$

So as the value of G is known much better than the value of H , let us express H via G :

$$H = \left(G \frac{45}{64\pi^5} \frac{\sigma T^4 I_4^2}{c^3 I_2} \right)^{1/2} = 2.14 \cdot 10^{-18} s^{-1}, \quad (3.30)$$

or in the units which are more familiar for many of us: $H = 66.875 \text{ km} \cdot s^{-1} \cdot \text{Mpc}^{-1}$.

This value of H is in the good accordance with the majority of present astrophysical estimations [3, 14], but it is lesser than some of them [15] and than it follows from the observed value of anomalous acceleration of Pioneer 10 [?] $w = (8.4 \pm 1.33) \cdot 10^{-10} \text{ m/s}^2$. Any massive body, moving relative to the background, must feel a deceleration $w \simeq Hc$ [2, ?]; with $H = 2.14 \cdot 10^{-18} s^{-1}$ we have $Hc = 6.419 \cdot 10^{-10} \text{ m/s}^2$.

The observed value of anomalous acceleration of Pioneer 10 should represent the vector difference of the two acceleration: an acceleration of Pioneer 10 relative to the graviton background, and an acceleration of the Earth relative to the background. Possibly, the last is displayed as an annual periodic

term in the residuals of Pioneer 10 [16]. If the solar system moves with a noticeable velocity relative to the background, the Earth's anomalous acceleration projection on the direction of this velocity will be smaller than for the Sun - because of the Earth's orbital motion. It means that in a frame of reference, connected with the Sun, the Earth should move with an anomalous acceleration having non-zero projections as well on the orbital velocity direction as on the direction of solar system motion relative to the background. Under some conditions, the Earth's anomalous acceleration in this frame of reference may be periodic. The axis of Earth's orbit should feel an annual precession by it.

3.5 Why and when gravity is geometry

The described quantum mechanism of classical gravity gives Newton's law with the constant G_2 value (25) and the connection (29) for the constants G_2 and H . We have obtained the rational value of H (30) by $G_2 = G$, if the condition of big distances is fulfilled:

$$\sigma(E_2, \langle \epsilon \rangle) \ll 4\pi r^2. \quad (3.31)$$

Because it is known from experience that for big bodies of the solar system, Newton's law is a very good approximation, one would expect that the condition (30) is fulfilled, for example, for the pair Sun-Earth. But assuming $r = 1 \text{ AU}$ and $E_2 = m_\odot c^2$, we obtain assuming for rough estimation $\langle \epsilon \rangle \rightarrow \bar{\epsilon}$:

$$\frac{\sigma(E_2, \langle \epsilon \rangle)}{4\pi r^2} \sim 4 \cdot 10^{12}.$$

It means that in the case of interaction of gravitons or graviton pairs with the Sun in the aggregate, the considered quantum mechanism of classical gravity could not lead to Newton's law as a good approximation. This "contradiction" with experience is eliminated if one assumes that gravitons interact with "small particles" of matter - for example, with atoms. If the Sun contains of N atoms, then $\sigma(E_2, \langle \epsilon \rangle) = N\sigma(E_a, \langle \epsilon \rangle)$, where E_a is an average energy of one atom. For rough estimation we assume here that $E_a = E_p$, where E_p is a proton rest energy; then it is $N \sim 10^{57}$, i.e. $\sigma(E_a, \langle \epsilon \rangle)/4\pi r^2 \sim 10^{-45} \ll 1$.

This necessity of "atomic structure" of matter for working the described quantum mechanism is natural relative to usual bodies. But would one expect that black holes have a similar structure? If any radiation cannot be

emitted with a black hole, a black hole should interact with gravitons as an aggregated object, i.e. the condition (31) for a black hole of sun mass has not been fulfilled even at distances $\sim 10^6 AU$.

For bodies without an atomic structure, the allowances, which are proportional to D^3/r^4 and are caused by decreasing a gravitonic flux due to the screening effect, will have a factor $m_1^2 m_2$ or $m_1 m_2^2$. These allowances break the equivalence principle for such the bodies.

For bodies with an atomic structure, a force of interaction is added up from small forces of interaction of their "atoms":

$$F \sim N_1 N_2 m_a^2 / r^2 = m_1 m_2 / r^2,$$

where N_1 and N_2 are numbers of atoms for bodies 1 and 2. The allowances to full forces due to the screening effect will be proportional to the quantity: $N_1 N_2 m_a^3 / r^4$, which can be expressed via the full masses of bodies as $m_1^2 m_2 / r^4 N_1$ or $m_1 m_2^2 / r^4 N_2$. By big numbers N_1 and N_2 the allowances will be small. The allowance to the force F , acting on body 2, will be equal to:

$$\Delta F = \frac{1}{2N_2} \int_0^\infty \frac{\sigma^2(E_2, < \epsilon_2 >)}{(4\pi r^2)^2} \cdot 4\sigma(E_1, < \epsilon_2 >) \cdot \frac{1}{3} \cdot \frac{4f_2(2\omega, T)}{c} d\omega = \quad (3.32)$$

$$\frac{2}{3N_2} \cdot \frac{D^3 c^3 (kT)^7 m_1 m_2^2}{\pi^4 \hbar^3 r^4} \cdot I_3,$$

(for body 1 we shall have the similar expression if replace $N_2 \rightarrow N_1$, $m_1 m_2^2 \rightarrow m_1^2 m_2$), where

$$I_3 \equiv \int_0^\infty \frac{x^6 (1 - \exp(-(\exp(2x) - 1)^{-1}))^3 (\exp(2x) - 1)^{-7}}{\exp(3(\exp(x) - 1)^{-1})} dx = 1.0988 \cdot 10^{-7}.$$

Let us find the ratio:

$$\frac{\Delta F}{F} = \frac{DE_2 kT}{N_2 2\pi r^2} \cdot \frac{I_3}{I_2}. \quad (3.33)$$

Using this formula, we can find by $E_2 = E_\odot$, $r = 1 AU$:

$$\frac{\Delta F}{F} \sim 10^{-46}. \quad (3.34)$$

An analogical allowance to the force F_1 has by the same conditions the order $\sim 10^{-48} F_1$, or $\sim 10^{-45} F$. One can replace E_p with a rest energy of very

big atom - the geometrical approach will left a very good language to describe the solar system. We see that for bodies with an atomic structure the considered mechanism leads to very small deviations from Einstein's equivalence principle, if the condition (31) is fulfilled for microparticles, which prompt interact with gravitons.

For small distances we shall have:

$$\sigma(E_2, \langle \epsilon \rangle) \sim 4\pi r^2. \quad (3.35)$$

It takes place by $E_a = E_p$, $\langle \epsilon \rangle \sim 10^{-3} \text{ eV}$ for $r \sim 10^{-11} \text{ m}$. This quantity is many order larger than the Planck length. The equivalence principle should be broken at such distances.

Under the condition (35), big digressions from Newton's law will be caused with two factors: 1) a screening portion of a running flux of gravitons is not small and it should be taken into account by computation of the repulsive force; 2) a value of this portion cannot be defined by the expression (4).

Instead of (4), one might describe this portion at small distances with an expression of the kind:

$$\frac{1}{2}(1 + \sigma(E_a, \langle \epsilon \rangle)/\pi r^2 - (1 + \sigma(E_a, \langle \epsilon \rangle)/\pi r^2)^{1/2}) \quad (3.36)$$

(the formula for a spheric segment area is used here [17]). Formally, by $\sigma(E_a, \langle \epsilon \rangle)/\pi r^2 \rightarrow \infty$ we shall have for the portion (36):

$$\sim \frac{1}{2}(\sigma(E_a, \langle \epsilon \rangle)/\pi r^2 - (\sigma(E_a, \langle \epsilon \rangle)/\pi)^{1/2}/r),$$

where the second term shows that the interaction should be weaker at small distances. We might expect that a screening portion may tend to a fixing value at super-short distances. But, of course, at such distances the interaction will be super-strong and our naive approach would be not valid.

3.6 Conclusion

It is known that giant intellectual efforts to construct a quantum theory of metric field, based on the theory of general relativity, have not a hit until today (see the recent review [18]). From a point of view of the considered approach, one may explain it by the fact that gravity is not geometry at short

distances $\sim 10^{-11}$ m. Actually, it means that at such the distances quantum gravity cannot be described alone but only in some unified manner, together with other interactions including the strong one.

It follows from section 5 of the present work that the geometrical description of gravity should be a good idealization at big distances by the condition of "atomic structure" of matter. This condition cannot be accepted only for black holes which must interact with gravitons as aggregated objects. In addition, the equivalence principle is roughly broken for black holes, if the described quantum mechanism of classical gravity is realized in the nature.

Other important features of this mechanism are the following ones.

- Attracting bodies are not initial sources of gravitons. In this sense, a future theory must be non-local to describe gravitons running from infinity. Non-local models were considered by Efimov in his book [19]. The idea to describe gravity as an effect caused by running ab extra particles was criticized by the great physicist Richard Feynman in his public lectures at Cornell University [20], but the Pioneer 10 anomaly [?], perhaps, is a good contra argument pro this idea.
- Newton's law takes place if gravitons are pairing; to get preponderance of attraction under repulsion, graviton pairs should be destructed by interaction with matter particles.
- The described quantum mechanism of classical gravity is obviously asymmetric relative to the time inversion. By the time inversion, single gravitons would run against bodies forming pairs. It would lead to replacing a body attraction with a repulsion. But such the change will do impossible graviton pairing. Cosmological models with the inversion of the time arrow were considered by Sakharov [21]. Penrose reasoned about a hidden physical law determining the time arrow direction [22]; it will be interesting if realization in the nature of Newton's law determines this direction.
- The two fundamental constants - Newton's and Hubble's ones - are connected with each other in such the model. The estimate of Hubble's constant has been got here using an additional postulate $P_1 = P(1, 2x)$ for pairing gravitons.
- It is proven that graviton pairs should be distributed in two modes with different spin projections.
- From thermodynamic reasons, it is assumed here that the graviton background has the same temperature as the microwave background. Also it follows from the condition of detail equilibrium, that both backgrounds should have the planckian spectra. Composite gravitons will have spin 2, if single

gravitons have the same spin as photons. The question arise, of course: how are gravitons and photons connected? Has the conjecture by Adler et al. [11] (that a graviton with spin 2 is composed with two photons) chances to be true? Intuitive demur calls forth a huge self-action, photons should be endowed with which - but one may get a unified theory on this way. To verify this conjecture in experiment, one would search for transitions in interstellar gas molecules caused by the microwave background, with an angular momentum change corresponding to absorption of spin 2 particles (photon pairs). A frequency of such the transitions should correspond to an equivalent temperature of the sub-system of these composite particles $T_2 = 0.5946T$, if T is a temperature of the microwave background.

A future theory dealing with gravitons as usual particles having an energy, a momentum etc ("gravitonics" would be a fine name for it) should have a number of features, which are not characterizing any existing model, to image the recounted above features of a possible quantum mechanism of gravity.

The main results of this work were poster presented at MG10 and Thinking'03 [23, 24].

Bibliography

- [1] M.A.Ivanov, General Relativity and Gravitation, **33**, 479 (2001); Erratum: **35**, 939 (2003); [astro-ph/0005084 v2] (see Chapter 1).
- [2] M.A.Ivanov, [gr-qc/0009043]; Proc. of the Int. Symp. "Frontiers of Fundamental Physics 4" (9-13 Dec 2000, Hyderabad, India), Eds B.G. Sidharth and M.V. Altaisky, Kluwer Academic/Plenum Publishers, August 2001; Proc. of the 4th Edoardo Amaldi Conference on Gravitational Waves (Perth, Western Australia, 8-13 July 2001) Class. Quantum Grav. **19**, 1351 (2002).
- [3] A.G. Riess et al. AJ **116**, 1009 (1998).
- [4] Anderson, J.D. et al. Phys. Rev. Lett., 1998, v.81, p. 2858; Phys. Rev. **D65** (2002) 082004. [gr-qc/0104064 v4]
- [5] M.A.Ivanov. Model of graviton-dusty universe. [gr-qc/0107047] (see Chapter 2).
- [6] M.P. Bronshtein. JETP, **6** (1936) 195.
- [7] W. Pauli, M. Fierz. Proc. Roy. Soc., **A173** (1939) 212.
- [8] S. Weinberg. In the Einstein Survey "General Relativity", Eds. S.W. Hawking, and W. Israel, Cambridge University Press, 1979.
- [9] Raman Sundrum. JHEP **9907** (1999) 001 [hep-ph/9708329].
- [10] W. Siegel. Phys.Rev. **D49** (1994) 4144 [hep-th/9312117].

- [11] S.L. Adler et al. Phys.Rev. **D14** (1976) 359.
- [12] S.L. Adler. Phys.Rev. **D14** (1976) 379.
- [13] S.W. Hawking. Commun. Math. Phys., **43** (1975) 199.
- [14] W. L. Freedman et al. ApJ, **553** (2001) 47.
- [15] J.A. Willick, Puneet Batra. ApJ, **548** (2001) 564.
- [16] S.G.Turyshev et al. XXXIV-th Rencontres de Moriond Meeting on Gravitational Waves and Experimental Gravity. Les Arcs, Savoie, France (January 23-30, 1999). [gr-qc/9903024 v2]
- [17] G.A. Korn, T.M. Korn. Mathematical Handbook, Second Edition, McGraw-Hill Book Co., New York, 1968, Table 1.10-2.
- [18] S. Carlip. Rept.Prog.Phys. 64 (2001) 885. [gr-qc/0108040]
- [19] G.V. Efimov. Non-local interactions of quantized fields. Nauka, Moscow, 1968.
- [20] R. Feynman. The character of physical law. Cox and Wyman Ltd., London, 1965.
- [21] A.D. Sakharov. JETP, **79** (1980) 689.
- [22] R. Penrose. In the Einstein Survey "General Relativity", Eds. S.W. Hawking, and W. Israel, Cambridge University Press, 1979.
- [23] M.A.Ivanov. Contribution to the TENTH MARCEL GROSS-MANN MEETING on General Relativity (MG10), 20-26 July 2003, Rio de Janeiro, Brazil (a 3-page abstract has been published in the Proceedings); [gr-qc/0307093].
- [24] M.A.Ivanov. In the Proceedings of the Conference "Thinking, Observing and Mining the Universe" (Thinking2003), 22-27 Sep 2003, Sorrento, Italy; [astro-ph/0309566].

Chapter 4

Super-strong interacting gravitons as a main engine of the universe without expansion or dark energy

1

The basic cosmological conjecture about the Dopplerian nature of redshifts may be false if gravitons are super-strong interacting particles. A quantum mechanism of classical gravity and the main features of a new cosmological paradigm based on it are described here.

If we assume that the background of super-strong interacting gravitons exists, then the classical gravitational attraction between any pair of bodies arises due to a Le Sage's kind mechanism. A net force of attraction and repulsion will be non-zero if one suggests that graviton pairs exist and these pairs are destructed by collisions. This pairing is like to the one having place in a case of superconductivity. The portion of pairing gravitons, $2\bar{n}_2/\bar{n}$, a spectrum of single gravitons, $f(x)$, and a spectrum of subsystem of pairing gravitons, $f_2(2x)$, are shown on Fig. 1 as functions of the dimensionless parameter $x \equiv \hbar\omega/kT$ (for more details, see [1]).

¹Contribution to The sixth international symposium "Frontiers of Fundamental and Computational Physics" (FFP6), 26-29 September 2004, Udine, Italy. [arXiv:astro-ph/0409631v2]

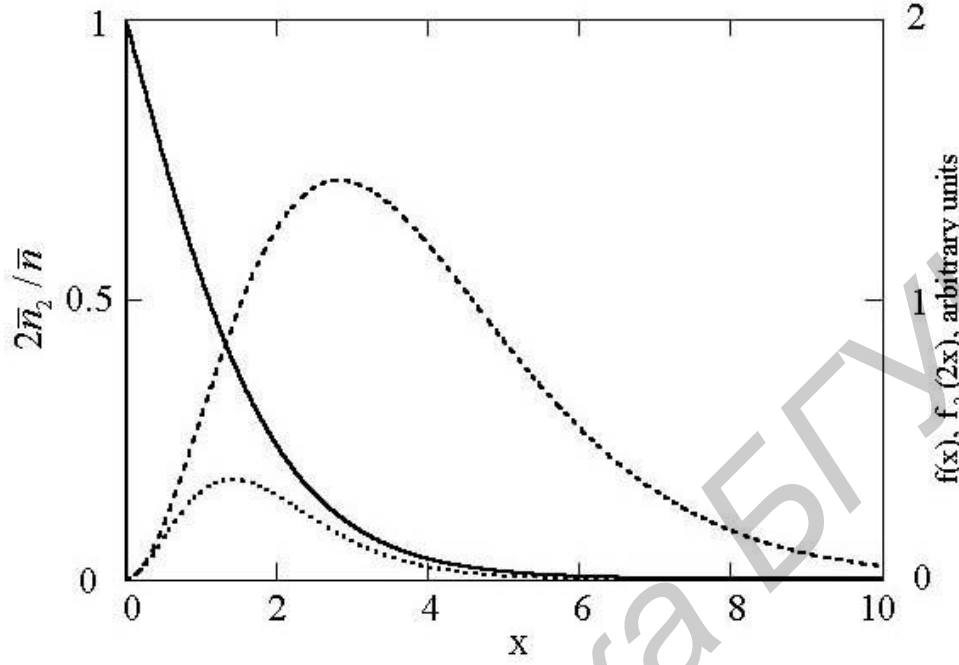

Figure 4.1: The portion of pairing gravitons, $2\bar{n}_2/\bar{n}$, (solid line), a spectrum of single gravitons, $f(x)$, (dashed line), and a spectrum of graviton pairs, $f_2(2x)$, (dotted line) versus the dimensionless parameter x .

By the Planckian spectra of gravitons we find for the Newtonian constant [1]:

$$G = \frac{2}{3} \cdot \frac{D^2 c (kT)^6}{\pi^3 \hbar^3} \cdot I_2 \quad (4.1)$$

where $I_2 = 2.3184 \cdot 10^{-6}$, T is an effective temperature of the background, and D is some new dimensional constant. It is necessary to accept for a value of this constant: $D = 1.124 \cdot 10^{-27} m^2/eV^2$.

In a presence of the graviton background, which is considered in a flat space-time, an energy of any photon should decrease with a distance r , so we have for a redshift z [2]: $z = \exp(ar) - 1$, where $a = H/c$ with the Hubble constant:

$$H = \frac{1}{2\pi} D \cdot \bar{\epsilon} \cdot (\sigma T^4), \quad (4.2)$$

where $\bar{\epsilon}$ is an average graviton energy, σ is the Stephan-Boltzmann constant.

It means that in this approach the two fundamental constants, G and H ,

are connected between themselves:

$$H = \left(G \frac{45}{32\pi^5} \frac{\sigma T^4 I_4^2}{c^3 I_2} \right)^{1/2}, \quad (4.3)$$

with $I_4 = 24.866$. Using the known value of G , one can compute: $H = 3.026 \cdot 10^{-18} s^{-1} = 94.576 km \cdot s^{-1} \cdot Mpc^{-1}$ by $T = 2.7K$.

From another side, an additional relaxation of any photonic flux due to non-forehead collisions of gravitons with photons leads to a luminosity distance D_L :

$$D_L = a^{-1} \ln(1+z) \cdot (1+z)^{(1+b)/2} \equiv a^{-1} f_1(z), \quad (4.4)$$

where $b = 3/2 + 2/\pi = 2.137$.

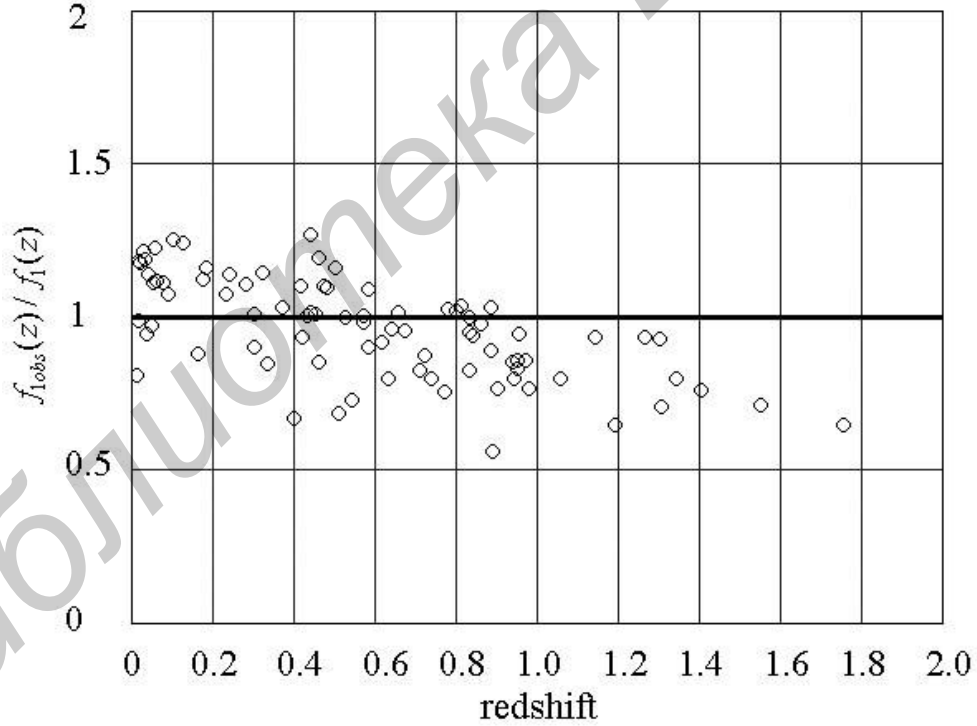

Figure 4.2: The ratio of observed to theoretical functions $f_{1obs}(z)/f_1(z)$ (dots); observational data are taken from Table 5 of [3]. If this model is true, the ratio should be equal to 1 for any z (solid line).

This function fits supernovae data well for $z < 0.5$ [4]. It excludes a need of any dark energy to explain supernovae dimming. If one introduces distance moduli $\mu_0 = 5 \log D_L + 25 = 5 \log f_{1obs} + c_1$, where c_1 is a constant, $f_{1obs}(z)$ is an observed analog of $f_1(z)$, we can compute the ratio $f_{1obs}(z)/f_1(z)$ using recent supernovae observational data from [3] (see Fig. 2).

The question arises: how are gravitons and photons connected? If the conjecture by Adler et al. [5] (that a graviton with spin 2 is composed with two photons) is true, one might check it in a laser experiment. Taking two lasers with photon energies $h\nu_1$ and $h\nu_2$, one may force laser beams to collide on a way L (see Fig. 3). If photons self-interact, then photons with energies $h\nu_1 - h\nu_2$, if $h\nu_1 > h\nu_2$, would arise after collisions of initial photons. If we *assume* that single gravitons are identical to photons, then an average

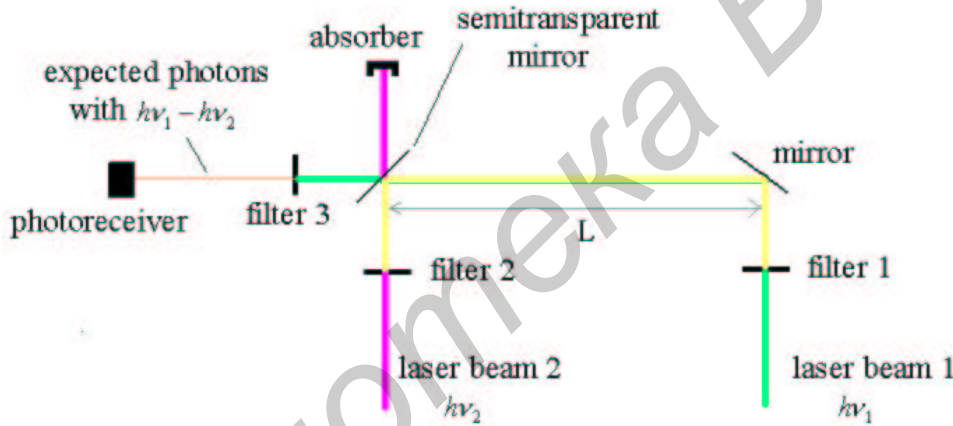

Figure 4.3: The scheme of laser beam passes.

graviton energy should be replaced with $h\nu_2$, the factor $1/2\pi$ in (2) should be replaced with $1/\varphi$, where φ is a divergence of laser beam 2, and one must use a quantity P/S instead of σT^4 in (2), where P is a laser 2 power and S is a cross-section of its beam. It means that we should replace the Hubble constant with its analog for a laser beam collision, H_{laser} : $H \rightarrow H_{laser} = \frac{1}{\varphi} \cdot D \cdot h\nu_2 \cdot \frac{P}{S}$. Taken $\varphi = 10^{-4}$, $h\nu_2 \sim 1 \text{ eV}$, $P \sim 10 \text{ mW}$, and $P/S \sim 10^3 \text{ W/m}^2$, that is characterizing a He-Ne laser, we get: $H_{laser} \sim 0.06 \text{ s}^{-1}$. Then photons with energies $h\nu_1 - h\nu_2$ would fall to a photoreceiver with a frequency which should linearly rise with L , and it would be of 10^7 s^{-1} if both lasers have equal powers $\sim 10 \text{ mW}$, and $L \sim 1 \text{ m}$. It is a big enough frequency to detect

easy a flux of these expected photons in the IR band.

In this approach (its summarizing description [6] will be soon published), every massive body would be decelerated due to collisions with gravitons [2] that may be connected with the Pioneer 10 anomaly [7].

Библиотека БГУИР

Bibliography

- [1] M.A. Ivanov. Screening the graviton background, graviton pairing, and Newtonian gravity [gr-qc/0207006] (see Chapter 3).
- [2] M.A. Ivanov, *General Relativity and Gravitation*, **33**, 479 (2001); Erratum: **35**, 939 (2003); [astro-ph/0005084 v2] (see Chapter 1).
- [3] A.G. Riess et al. Type Ia Supernova Discoveries at $z > 1$ From the Hubble Space Telescope ..., [astro-ph/0402512] (to appear in ApJ, 2004).
- [4] M.A. Ivanov. Another possible interpretation of SN 1a data - without kinematics: Comments on the paper astro-ph/0402512 by A. Riess et al. [astro-ph/0403130].
- [5] Adler, S.L. et al. *Phys. Rev.* **D14**, 359 (1976).
- [6] M.A. Ivanov. Gravitons as super-strong interacting particles, and low-energy quantum gravity. Invited chapter for the volume *Progress in Quantum Gravity Research*, accepted by Nova Science Publishers, in plan of 2005 [<http://ivanovma.narod.ru/nova04abstract.html>].
- [7] J.D. Anderson et al. *Phys. Rev. Lett.* **81**, 2858 (1998); *Phys. Rev.* **D65** 082004 (2002); [gr-qc/0104064 v4]

Chapter 5

May gravitons be super-strong interacting particles?

1

A scheme, in which gravitons are super-strong interacting, is described. The graviton background with the Planckian spectrum and a small effective temperature is considered as a reservoir of gravitons. A cross-section of interaction of a graviton with any particle is assumed to be a bilinear function of its energies. Any pair of bodies are attracting not due to an exchange with its own gravitons, but due to a pressure of external gravitons of this background. A graviton pairing is necessary to obtain classical gravity. Any divergencies are not possible in such the model because of natural smooth cut-offs of the graviton spectrum from both sides. Some cosmological consequences of this scheme are discussed, too. Also it is shown here that the main conjecture of this approach may be verified at present on the Earth.

5.1 Introduction

What is a quantum mechanism of gravity? To answer this question, it is necessary to keep in mind a few different circumstances. A commonly accepted hypothesis, that an exchange with gravitons, which are radiated by bodies itself, causes classical gravity, is not a single possible one - gravitons might belong to an external sea of particles which exists independently of

¹Contribution to The 14th Workshop on General Relativity and Gravitation (JGRG14), Nov 29 - Dec 3 2004, Kyoto, Japan. [arXiv:gr-qc/0410076v1]

attracting bodies. A coupling constant of quantum gravitational interaction would differ from the Newton constant and may depend on energies of interacting particles. A geometrical language for short distances may not be adequate to describe quantum gravity. Perhaps, on the present stage when we know so a little about this mechanism, it would be better to consider a problem of its searching as a separate one. Some known effects which are not usually connected with gravity may be involved in a circle of interests of researchers by considerations of possible mechanisms. At first, it concerns cosmological effects which manifest themselves only on huge distances and during big times.

There are some facts beyond cosmology, which should be taken into account in this search, too. The Pioneer 10 anomaly [1] is one of them. Another fact is an observation of discrete energy states of neutrons in the Earth's gravitational field by Nesvizhevsky et al. [2]. In this remarkable experiment we see the huge difference - about 40 orders - between observed state energies $\sim 10^{-12}$ eV and the Planck energy of $\sim 10^{19}$ GeV which is expected from dimension reasonings as a threshold of any quantum gravity effect. The long known contradiction between the general relativity and quantum mechanics in descriptions of a microparticle motion is the third fact: if in one theory all particles should move on geodesics, in another they cannot move on definite trajectories. Maybe, a cause of this contradiction is that both theories do not take into account influences of single gravitons on a microparticle; then small graviton energies in a future theory are appeared to be more appropriate than the Planckian ones. A possible compositeness [3] of the fundamental fermions - electrons, neutrinos, quarks etc - should be taken into account, too. Components of these composite fermions would be bounded with a quantum gravitational interaction which is not similar to ordinary gravity.

The main features of a quantum model of classical gravity and its cosmological consequences are described here. The model is based on the conjecture about an existence of the background of super-strong interacting gravitons.

5.2 A gravitational attraction due to the background

The important features of this model are the following ones (for more details, see [4, 5]).

- The graviton background has the Planckian spectrum and the same temperature T as CMB.
- The graviton background is in a state of dynamical equilibrium: it is cooled via self-interactions of gravitons and formation of virtual massive gravitons which may be dark matter particles, and is heated up via interactions with other radiations [6].
- A cross-section of interaction $\sigma(E, \epsilon)$ of a graviton with any particle is a bilinear function of its energies: $\sigma(E, \epsilon) = D \cdot E \cdot \epsilon$, where D is some new dimensional constant, E is a particle's energy, ϵ is a graviton's energy. The estimate of D is: $D \sim 10^{-27} m^2 / eV^2$, i.e. gravitons are super-strong interacting particles.
- Due to a pressure of single gravitons, there act equal attractive and repulsive forces of three order greater than the Newtonian force between any two bodies, but a net force is equal to zero.
- To ensure Newtonian attraction, a pairing of single gravitons of running flux is necessary, and such pairs should be destructed by collisions with a body. A nature of this pairing remains unknown. If this pairs have spin 2, then single gravitons may have spin 1. Only two modes of spin-2 particles may exist in the model.
- Given this pairing, the Newton constant G is equal to:

$$G \equiv \frac{2}{3} \cdot \frac{D^2 c (kT)^6}{\pi^3 \hbar^3} \cdot I_2,$$

where k is the Boltzmann constant, $I_2 = 2.3184 \cdot 10^{-6}$.

- In the case of interaction of gravitons with big bodies in the aggregate, it is impossible to have Newton's law. One needs an "atomic structure" of matter to get this law.
- For proton-mass particles, the equivalence principle should be broken at distances $\sim 10^{-11} m$, if the model is true. It means that at shorter distances gravity cannot be described alone, without other known interactions. It is also the limit to apply a geometrical language in gravity.

5.3 Cosmological consequences of the model

Such the mechanism of gravity should have the following cosmological consequences [7, 4]:

5.4. HOW TO VERIFY THE MAIN CONJECTURE OF THIS APPROACH 55

- A quantum interaction of photons with the graviton background would lead to redshifts of remote objects; the Hubble constant H is equal in this model to: $H = \frac{1}{2\pi} D \cdot \bar{\epsilon} \cdot (\sigma T^4)$, where $\bar{\epsilon}$ is an average graviton energy, σ is the Stephan-Boltzmann constant. Redshifts are caused by forehead collisions with gravitons.
- The Hubble constant is connected in this approach with the Newton one as:

$$H = \left(G \frac{45}{32\pi^5} \frac{\sigma T^4 I_4^2}{c^3 I_2} \right)^{1/2} = 3.026 \cdot 10^{-18} s^{-1},$$

where $I_4 = 24.866$.

- Due to non-forehead collisions with gravitons, an additional relaxation of any photonic flux leads to the luminosity distance D_L :

$$D_L = a^{-1} \ln(1+z) \cdot (1+z)^{(1+b)/2},$$

where $a = H/c$, z is a redshift, and the relaxation factor b is equal to [8]: $b = 3/2 + 2/\pi = 2.137$. See a comparison of this function with observations of [9] in my paper [10].

- Any light radiation spectrum will be deformed due to the quantum nature of red-shifting process. A theory of this effect does not exist today. But it may be checked experimentally in a laser experiment (see the next section).
- Any massive objects, moving relative to the background, should be decelerated by the background. A body's acceleration w by a non-zero velocity v relative to the background is equal to: $w = -ac^2(1 - v^2/c^2)$, and has by small velocities the same order Hc as an anomalous acceleration of Pioneer 10 [1].
- An existence of black holes contradicts to Einstein's equivalence principle in a frame of this model [4].

5.4 How to verify the main conjecture of this approach

I would like to show here a full realizability at present time of verifying my basic conjecture about the quantum gravitational nature of redshifts in a ground-based laser experiment. Of course, many details of this precision experiment will be in full authority of experimentalists.

It was not clear in 1995 how big is a temperature of the graviton background, and my proposal [11] to verify the conjecture about the described

local quantum character of redshifts turned out to be very rigid: a laser with instability of $\sim 10^{-17}$ hasn't appeared after 9 years. But if $T = 2.7K$, the satellite of main laser line of frequency ν after passing the delay line will be red-shifted at $\sim 10^{-3}$ eV/h and its position will be fixed, but, due to the quantum nature of shifting process, the ratio of its intensity to main line's intensity should have the order:

$$\sim \frac{h\nu}{\bar{\epsilon}} \frac{H}{c} l,$$

where l is a path of laser photons in a vacuum tube of delay line. It gives us a possibility to plan a laser-based experiment to verify the basic conjecture of this approach with much softer demands to the equipment. An instability of a laser of a power P must be only $\ll 10^{-3}$ if a photon energy is of ~ 1 eV. If one compares intensities of the red-shifted satellite at the very beginning of the path l and after it, and uses a single photon counter to measure the ones (when q is a quantum output of a cathode of the used photomultiplier, N_n is a frequency of its noise pulses, and n is a desired ratio of a signal to noise's standard deviation), then an evaluated time duration t of collecting data would have the order:

$$t = \frac{\bar{\epsilon}^2 c^2}{H^2} \frac{n^2 N_n}{q^2 P^2 l^2}.$$

Assuming $n = 10$, $N_n = 10^3$ s $^{-1}$, $q = 0.3$, $P = 300$ W, $l = 100$ m, we get: $t \sim 4$ days, that is acceptable for the experiment of such the potential importance.

5.5 Conclusion

The described model of Le Sage's kind has not an analogue in present-day physics of particles. If this mechanism is realized in the nature, both the general relativity and quantum mechanics should be modified. The indirectly observed objects in centers of galaxies, which are known now as black holes, should have another nature, too. Gravity at short distances, which are meantime much bigger than the Planck length, needs to be described only in some unified manner.

Bibliography

- [1] J.D. Anderson et al. Phys. Rev. Lett., **81** (1998) 2858; Phys. Rev. **D65** (2002) 082004. [gr-qc/0104064 v4]
- [2] V.V. Nesvizhevsky et al. Nature, **415** (2002) 297.
- [3] M.A. Ivanov. Nuovo Cimento, **105A** (1992) 77. [hep-th/0207210]
- [4] M.A. Ivanov. Screening the graviton background, graviton pairing, and Newtonian gravity. [gr-qc/0207006] (see Chapter 3).
- [5] M.A. Ivanov. In the book "Searches for a mechanism of gravity", Eds. M.A. Ivanov, L.A. Savrov, Nizhny Novgorod, Yu.A. Nikolaev Publisher, 2004, pp 275-282 (in Russian). [gr-qc/0307093]
- [6] M.A. Ivanov. Model of graviton-dusty universe. [gr-qc/0107047] (see Chapter 2).
- [7] M.A. Ivanov, General Relativity and Gravitation, **33**, 479 (2001); Erratum: **35**, 939 (2003); [astro-ph/0005084 v2] (see Chapter 1).
- [8] M.A. Ivanov. Another origin of cosmological redshifts. [astro-ph/0405083].
- [9] A.G. Riess et al. Type Ia Supernova Discoveries at $z > 1$ From the Hubble Space Telescope ..., [astro-ph/0402512] (to appear in ApJ, 2004).

- [10] M.A. Ivanov. Another possible interpretation of SN 1a data - without kinematics: Comments on the paper astro-ph/0402512 by A. Riess et al. [astro-ph/0403130].
- [11] M.A. Ivanov. Contribution to the Quantum Electronics and Laser Science Conference (QELS'95), May 21-26, 1995, Baltimore, USA; paper number: QThG1.

Библиотека БГУИР

Chapter 6

Low-energy quantum gravity leads to another picture of the universe

1

If gravitons are super-strong interacting particles and the low-temperature graviton background exists, the basic cosmological conjecture about the Dopplerian nature of redshifts may be false: a full magnitude of cosmological redshift would be caused by interactions of photons with gravitons. Non-forehead collisions with gravitons will lead to a very specific additional relaxation of any photonic flux that gives a possibility of another interpretation of supernovae 1a data - without any kinematics. These facts may implicate a necessity to change the standard cosmological paradigm. Some features of a new paradigm are discussed. In a frame of this model, every observer has two different cosmological horizons. One of them is defined by maximum existing temperatures of remote sources - by big enough distances, all of them will be masked with the CMB radiation. Another, and much smaller, one depends on their maximum luminosity - the luminosity distance increases with a redshift much quickly than the geometrical one.

If the considered quantum mechanism of classical gravity is realized in the nature, than an existence of black holes contradicts to the equivalence principle. In this approach, the two fundamental constants - Hubble's and

¹Contribution to the 1st Crisis in Cosmology Conference (CCC-1), Moncao, Portugal, 23-25 June 2005, AIPConf.Proc.822:187-199,2006. [arXiv:astro-ph/0505310v3]

Newton's ones - should be connected between themselves. The theoretical value of the Hubble constant is computed. Also, every massive body would be decelerated due to collisions with gravitons that may be connected with the Pioneer 10 anomaly.

6.1 Introduction

An opinion is commonly accepted that quantum gravity should manifest itself only on the Planck scale of energies, i.e. it is a high-energy phenomenon. The value of the Planck energy $\sim 10^{19}$ GeV has been got from dimensional reasonings. Still one wide-spread opinion is that we know a mechanism of gravity (bodies are exchanging with gravitons of spin 2) but cannot correctly describe it.

In a few last years, the situation has been abruptly changed. I enumerate those discoveries and observations which may force, in my opinion, the ice to break up.

1. In 1998, Anderson's team reported about the discovery of anomalous acceleration of NASA's probes Pioneer 10/11 [1]; this effect is not embedded in a frame of the general relativity, and its magnitude is somehow equal to $\sim Hc$, where H is the Hubble constant, c is the light velocity.

2. In the same 1998, two teams of astrophysicists, which were collecting supernovae 1a data with the aim to specificate parameters of cosmological expansion, reported about dimming remote supernovae [2, 3]; the one would be explained on a basis of the Doppler effect if at present epoch the universe expands with acceleration. This explanation needs an introduction of some "dark energy" which is unknown from any laboratory experiments.

3. In January 2002, Nesvizhevsky's team reported about discovery of quantum states of ultra-cold neutrons in the Earth's gravitational field [4]. Observed energies of levels (it means that and their differences too) in full agreement with quantum-mechanical calculations turned out to be equal to $\sim 10^{-12}$ eV. The formula for energy levels had been found still by Bohr and Sommerfeld. If transitions between these levels are accompanied with irradiation of gravitons then energies of irradiated gravitons should have the same order - but it is of 40 orders lesser than the Planck energy by which one waits quantum manifestations of gravity.

The first of these discoveries obliges to muse about the borders of applicability of the general relativity, the third - about that quantum gravity

would be a high-energy phenomenon. It seems that the second discovery is far from quantum gravity but it obliges us to look at the traditional interpretation of the nature of cosmological redshift critically. An introduction into consideration of an alternative model of redshifts [5] which is based on a conjecture about an existence of the graviton background gives us odds to see in the effect of dimming supernovae an additional manifestation of low-energy quantum gravity. Under the definite conditions, an effective temperature of the background may be the same one as a temperature of the cosmic microwave background, with an average graviton energy of the order $\sim 10^{-3}$ eV.

In this contribution (it is a short version of my summarizing paper [6]), the main results of author's research in this approach are described. It is shown that if a redshift would be a quantum gravitational effect then one can get from its magnitude an estimate of a new dimensional constant characterizing a single act of interaction in this model. It is possible to calculate theoretically a dependence of a light flux relaxation on a redshift value, and this dependence fits supernova observational data very well at least for $z < 0.5$. Further it is possible to find a pressure of single gravitons of the background which acts on any pair of bodies due to screening the graviton background with the bodies [7]. It turns out that the pressure is huge (a corresponding force is ~ 1000 times stronger than the Newtonian attraction) but it is compensated with a pressure of gravitons which are re-scattered by the bodies. The Newtonian attraction arises if a part of gravitons of the background forms pairs which are destructed by interaction with bodies. It is interesting that both Hubble's and Newton's constants may be computed in this approach with the ones being connected between themselves. It allows us to get a theoretical estimate of the Hubble constant. An unexpected feature of this mechanism of gravity is a necessity of "an atomic structure" of matter - the mechanism doesn't work without the one.

Collisions with gravitons should also call forth a deceleration of massive bodies of order $\sim Hc$ - namely the same as of NASA's probes. But at present stage it turns out unclear why such the deceleration has *not* been observed for planets. The situation reminds by something of the one that took place in physics before the creation of quantum mechanics when a motion of electrons should, as it seemed by canons of classical physics, lead to their fall to a nucleus.

So, in this approach we deal with the following small quantum effects of low-energy gravity: redshifts, its analog - a deceleration of massive bodies,

and an additional relaxation of any light flux. The Newtonian attraction turns out to be the main statistical effect, with bodies themselves being not sources of gravitons - only correlational properties of *in* and *out* fluxes of gravitons in their neighbourhood are changed due to an interaction with bodies. There does still not exist a full and closed theory in this approach, but even the initial researches in this direction show that in this case quantum gravity cannot be described separately of other interactions, and also manifest the boundaries of applicability of a geometrical language in gravity.

6.2 Passing photons through the graviton background [5]

Let us introduce the hypothesis, which is considered in this approach as independent from the standard cosmological model: there exists the isotropic graviton background. Photon scattering is possible on gravitons $\gamma + h \rightarrow \gamma + h$, where γ is a photon and h is a graviton, if one of the gravitons is virtual. The energy-momentum conservation law prohibits energy transfer to free gravitons. Due to forehead collisions with gravitons, an energy of any photon should decrease when it passes through the sea of gravitons.

From another side, none-forehead collisions of photons with gravitons of the background will lead to an additional relaxation of a photon flux, caused by transmission of a momentum transversal component to some photons. It will lead to an additional dimming of any remote objects, and may be connected with supernova dimming.

We deal here with the uniform non-expanding universe with the Euclidean space, and there are not any cosmological kinematic effects in this model.

6.2.1 Forehead collisions with gravitons: an alternative explanations of the redshift nature

We shall take into account that a gravitational "charge" of a photon must be proportional to E (it gives the factor E^2 in a cross-section) and a normalization of a photon wave function gives the factor E^{-1} in the cross-section. Also we assume here that a photon average energy loss $\bar{\epsilon}$ in one act of interaction is relatively small to a photon energy E . Then average energy losses of a

photon with an energy E on a way dr will be equal to [5]:

$$dE = -aEdr, \quad (6.1)$$

where a is a constant. If a *whole* redshift magnitude is caused by this effect, we must identify $a = H/c$, where c is the light velocity, to have the Hubble law for small distances [8].

A photon energy E should depend on a distance from a source r as

$$E(r) = E_0 \exp(-ar), \quad (6.2)$$

where E_0 is an initial value of energy.

The expression (2) is just only so far as the condition $\bar{\epsilon} \ll E(r)$ takes place. Photons with a very small energy may lose or acquire an energy changing their direction of propagation after scattering. Early or late such photons should turn out in the thermodynamic equilibrium with the graviton background, flowing into their own background. Decay of virtual gravitons should give photon pairs for this background, too. Perhaps, the last one is the cosmic microwave background [9, 10].

It follows from the expression (2) that an exact dependence $r(z)$ is the following one:

$$r(z) = \ln(1 + z)/a, \quad (6.3)$$

if an interaction with the graviton background is the only cause of redshifts. It is very important, that this redshift does not depend on a light frequency. For small z , the dependence $r(z)$ will be linear.

The expressions (1) - (3) are the same that appear in other tired-light models (compare with [11]). In this approach, the ones follow from a possible existence of the isotropic graviton background, from quantum electrodynamics, and from the fact that a gravitational "charge" of a photon must be proportional to E .

6.2.2 Non-forehead collisions with gravitons: an additional dimming of any light flux

Photon flux's average energy losses on a way dr due to non-forehead collisions with gravitons should be proportional to $badr$, where b is a new constant of the order 1. These losses are connected with a rejection of a part of photons from a source-observer direction. Such the relaxation together with the redshift

will give a connection between visible object's diameter and its luminosity (i.e. the ratio of an object visible angular diameter to a square root of visible luminosity), distinguishing from the one of the standard cosmological model.

Let us consider that in a case of a non-forehead collision of a graviton with a photon, the latter leaves a photon flux detected by a remote observer (an assumption of a narrow beam of rays). The details of calculation of the theoretical value of relaxation factor b which was used in author's paper [5] were given later in the preprint [12]. So as both particles have velocities c , a cross-section of interaction, which is "visible" under an angle θ (see Fig. 1), will be equal to $\sigma_0 |\cos \theta|$ if σ_0 is a cross-section by forehead collisions. The function $|\cos \theta|$ allows to take into account both front and back hemispheres for riding gravitons. Additionally, a graviton flux, which falls on a picked out area (cross-section), depends on the angle θ . We have for the ratio of fluxes:

$$\Phi(\theta)/\Phi_0 = S_s/\sigma_0,$$

where $\Phi(\theta)$ and Φ_0 are the fluxes which fall on σ_0 under the angle θ and normally, S_s is a square of side surface of a truncated cone with a base σ_0 (see Fig. 1).

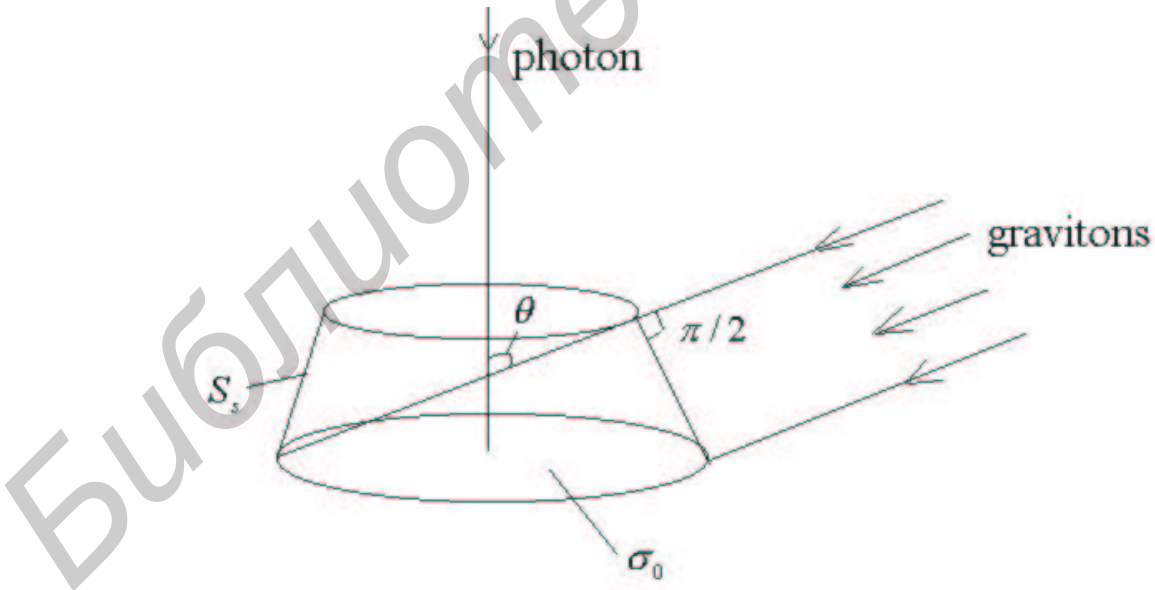

Figure 6.1: By non-forehead collisions of gravitons with a photon, it is necessary to calculate a cone's side surface square, S_s .

Finally, we get for the factor b :

$$b = 2 \int_0^{\pi/2} \cos \theta \cdot (S_s/\sigma_0) \frac{d\theta}{\pi/2}. \quad (6.4)$$

By $0 < \theta < \pi/4$, a formed cone contains self-intersections, and it is $S_s = 2\sigma_0 \cdot \cos \theta$. By $\pi/4 \leq \theta \leq \pi/2$, we have $S_s = 4\sigma_0 \cdot \sin^2 \theta \cos \theta$.

After computation of simple integrals, we get:

$$b = \frac{4}{\pi} \left(\int_0^{\pi/4} 2 \cos^2 \theta d\theta + \int_{\pi/4}^{\pi/2} \sin^2 2\theta d\theta \right) = \frac{3}{2} + \frac{2}{\pi} \simeq 2.137. \quad (6.5)$$

In the considered simplest case of the uniform non-expanding universe with the Euclidean space, we shall have the quantity

$$(1+z)^{(1+b)/2} \equiv (1+z)^{1.57}$$

in a visible object diameter-luminosity connection if a whole redshift magnitude would be caused by such an interaction with the background (instead of $(1+z)^2$ for the expanding uniform universe). For near sources, the estimate of the factor b will be some increased one.

The luminosity distance (see [2]) is a convenient quantity for astrophysical observations. Both redshifts and the additional relaxation of any photonic flux due to non-forehead collisions of gravitons with photons lead in our model to the following luminosity distance D_L :

$$D_L = a^{-1} \ln(1+z) \cdot (1+z)^{(1+b)/2} \equiv a^{-1} f_1(z), \quad (6.6)$$

where $f_1(z) \equiv \ln(1+z) \cdot (1+z)^{(1+b)/2}$.

6.2.3 Comparison of the theoretical predictions with supernova data

To compare a form of this predicted dependence $D_L(z)$ by unknown, but constant H , with the latest observational supernova data by Riess et al. [13], one can introduce distance moduli $\mu_0 = 5 \log D_L + 25 = 5 \log f_1 + c_1$, where c_1 is an unknown constant (it is a single free parameter to fit the data); f_1 is the luminosity distance in units of c/H . In Figure 2, the Hubble diagram $\mu_0(z)$ is shown with $c_1 = 43$ to fit observations for low redshifts; observational data (82 points) are taken from Table 5 of [13]. The predictions fit observations

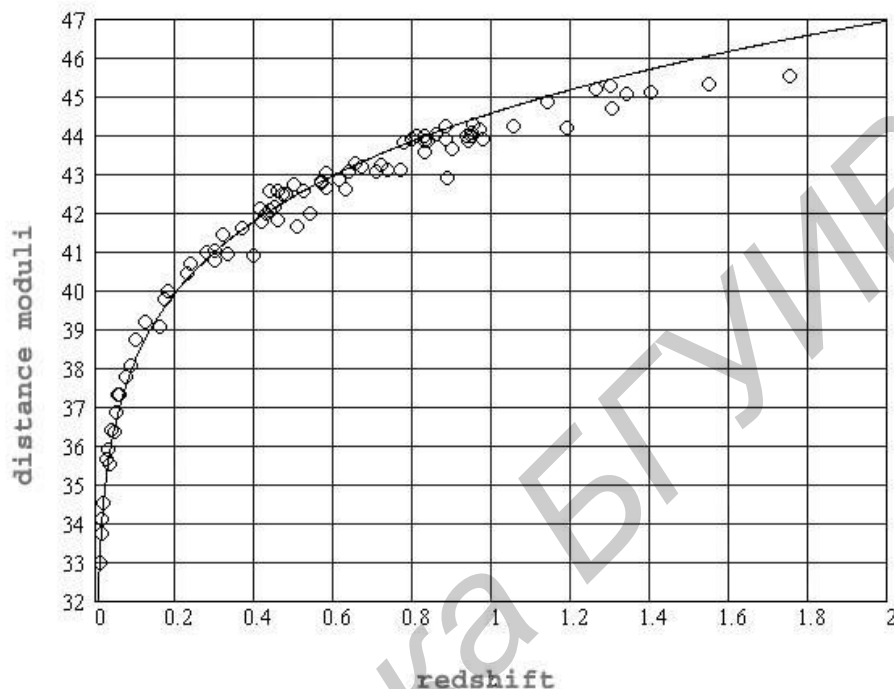

Figure 6.2: Comparison of the theoretical values of distance moduli $\mu_0(z)$ (solid line) with observations (points) from [13] by Riess et al.

very well for roughly $z < 0.5$. It excludes a need of any dark energy to explain supernovae dimming.

Discrepancies between predicted and observed values of $\mu_0(z)$ are obvious for higher z : we see that observations show brighter SNe that the theory allows, and a difference increases with z . It is better seen on Figure 3 with a linear scale for f_1 ; observations are transformed as $\mu_0 \rightarrow 10^{(\mu_0 - c_1)/5}$ with the same $c_1 = 43$.² It would be explained in the model as a result of specific deformation of SN spectra due to a discrete character of photon energy losses. Today, a theory of this effect does not exist, and I explain its origin only qualitatively [14]. For very small redshifts z , only a small part of photons transmits its energy to the background (see Fig. 8 in [6]). Therefore any red-shifted narrow spectral strip will be a superposition of two strips. One of

²A spread of observations raises with z ; it might be partially caused by quickly raising contribution of a dispersion of measured flux: it should be proportional to $f_1^6(z)$.

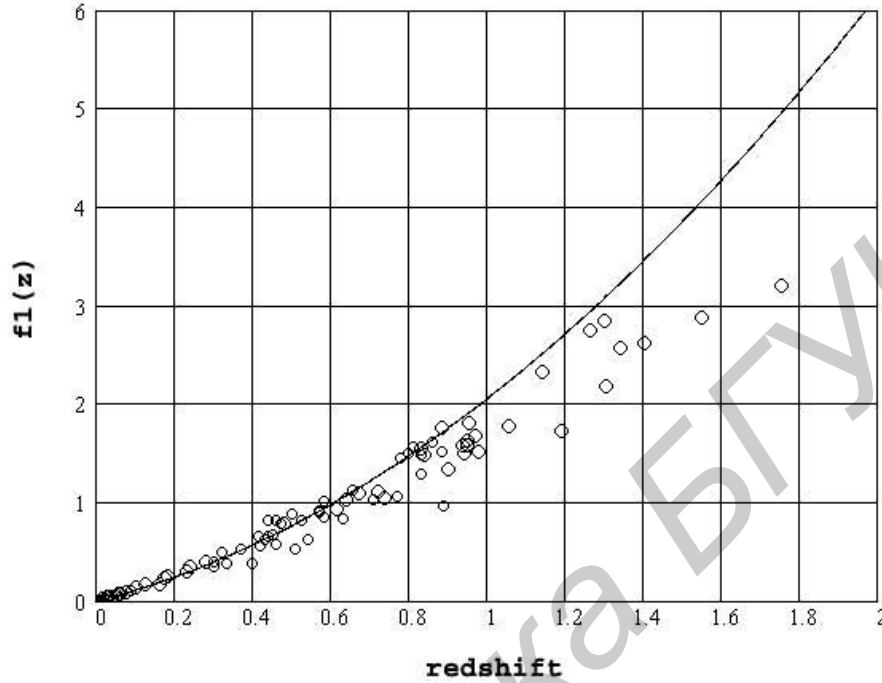

Figure 6.3: Predicted values of $f_1(z)$ (solid line) and observations (points) from [13] transformed to a linear scale

them has a form which is identical with an initial one, its space is proportional to $1 - n(r)$ where $n(r)$ is an average number of interactions of a single photon with the background, and its center's shift is negligible (for a narrow strip). Another part is expand, its space is proportional to $n(r)$, and its center's shift is equal to $\bar{\epsilon}_g/h$ where $\bar{\epsilon}_g$ is an average energy loss in one act of interaction. An amplitude of the red-shifted step should linear raise with a redshift. For big z , spectra of remote objects of the universe would be deformed. A deformation would appear because of multifold interactions of a initially-red-shifted part of photons with the graviton background. It means that the observed flux within a given passband would depend on a form of spectrum: the flux may be larger than an expected one without this effect if an initial flux within a next-blue neighbour band is big enough - due to a superposition of red-shifted parts of spectrum. Some other evidences of this effect would be an apparent variance of the fine structure constant [15] or of the CMB temperature [16] with epochs. In both cases, a ratio of red-shifted spectral line's intensities

may be sensitive to the effect. Also, this effect should be taken into account when one analyzes a temporal evolution of supernova spectra to detect the relativistic "time dilation" effect [17].

6.2.4 Computation of the Hubble constant

Let us consider that a full redshift magnitude is caused by an interaction with single gravitons. If $\sigma(E, \epsilon)$ is a cross-section of interaction by forehead collisions of a photon with an energy E with a graviton, having an energy ϵ , we consider really (see (1)), that

$$\frac{d\sigma(E, \epsilon)}{E d\Omega} = \text{const}(E),$$

where $d\Omega$ is a space angle element, and the function $\text{const}(x)$ has a constant value for any x . If $f(\omega, T)d\Omega/2\pi$ is a spectral density of graviton flux in the limits of $d\Omega$ in some direction (ω is a graviton frequency, $\epsilon = \hbar\omega$), i.e. an intensity of a graviton flux is equal to the integral $(d\Omega/2\pi) \int_0^\infty f(\omega, T)d\omega$, T is an equivalent temperature of the graviton background, we can write for the Hubble constant $H = ac$, introduced in the expression (1):

$$H = \frac{1}{2\pi} \int_0^\infty \frac{\sigma(E, \epsilon)}{E} f(\omega, T)d\omega.$$

If $f(\omega, T)$ can be described by the Planck formula for equilibrium radiation, then

$$\int_0^\infty f(\omega, T)d\omega = \sigma T^4,$$

where σ is the Stephan- Boltzmann constant. As carriers of a gravitational "charge" (without consideration of spin properties), gravitons should be described in the same manner as photons , i.e. one can write for them:

$$\frac{d\sigma(E, \epsilon)}{\epsilon d\Omega} = \text{const}(\epsilon).$$

Now let us introduce a new dimensional constant D , so that for forehead collisions:

$$\sigma(E, \epsilon) = D \cdot E \cdot \epsilon. \quad (6.7)$$

Then

$$H = \frac{1}{2\pi} D \cdot \bar{\epsilon} \cdot (\sigma T^4), \quad (6.8)$$

where $\bar{\epsilon}$ is an average graviton energy. Assuming $T \sim 3K$, $\bar{\epsilon} \sim 10^{-4} eV$, and $H = 1.6 \cdot 10^{-18} s^{-1}$, we get the following rough estimate for D :

$$D \sim 10^{-27} m^2/eV^2,$$

(see below Section 4.3 for more exact estimate of D and for a theoretical estimate of H) that gives us the phenomenological estimate of cross-section by the same and equal E and $\bar{\epsilon}$:

$$\sigma(E, \bar{\epsilon}) \sim 10^{-35} m^2.$$

6.3 Deceleration of massive bodies: an analog of redshifts

As it was reported by Anderson's team [1], NASA deep-space probes (Pioneer 10/11, Galileo, and Ulysses) experience a small additional constant acceleration, directed towards the Sun (the Pioneer anomaly). Today, a possible origin of the effect is unknown. It must be noted here that the reported direction of additional acceleration may be a result of the simplest conjecture, which was accepted by the authors to provide a good fit for all probes. One should compare different conjectures to choose the one giving the best fit.

We consider here a deceleration of massive bodies, which would give a similar deformation of cosmic probes' trajectories [5]. The one would be a result of interaction of a massive body with the graviton background, but such an additional acceleration will be directed against a body velocity.

It follows from a universality of gravitational interaction, that not only photons, but all other objects, moving relative to the background, should lose their energy, too, due to such a quantum interaction with gravitons. If $a = H/c$, it turns out that massive bodies must feel a constant deceleration of the same order of magnitude as a small additional acceleration of cosmic probes.

Let us now denote as E a full energy of a moving body which has a velocity v relative to the background. Then energy losses of the body by an interaction with the graviton background (due to forehead collisions with gravitons) on the way dr must be expressed by the same formula (1):

$$dE = -aE dr,$$

where $a = H/c$. If $dr = vdt$, where t is a time, and $E = mc^2/\sqrt{1 - v^2/c^2}$, then we get for the body acceleration $w \equiv dv/dt$ by a non-zero velocity:

$$w = -ac^2(1 - v^2/c^2). \quad (6.9)$$

We assume here, that non-forehead collisions with gravitons give only stochastic deviations of a massive body's velocity direction, which are negligible. For small velocities:

$$w \simeq -Hc. \quad (6.10)$$

If the Hubble constant H is equal to $3.026 \cdot 10^{-18} s^{-1}$ (it is the theoretical estimate of H in this approach, see below Section 4.3), a modulus of the acceleration will be equal to

$$|w| \simeq Hc = 9.078 \cdot 10^{-10} m/s^2, \quad (6.11)$$

that is in the very good accordance with a value of the observed additional acceleration $(8.74 \pm 1.33) \cdot 10^{-10} m/s^2$ for NASA probes.

I must emphasize here that the acceleration w is directed against a body velocity only in a special frame of reference (in which the graviton background is isotropic). I would like to note that a deep-space mission to test the discovered anomaly is planned now at NASA by the authors of this very important discovery [18].

It is very important to understand, why such an acceleration has not been observed for planets. This acceleration will have different directions by motion of a body on a closed orbit, and one must take into account a solar system motion, too. As a result, an orbit should be deformed. The observed value of anomalous acceleration of Pioneer 10 should represent the vector difference of the two accelerations [7]: an acceleration of Pioneer 10 relative to the graviton background, and an acceleration of the Earth relative to the background. Possibly, the last is displayed as an annual periodic term in the residuals of Pioneer 10 [19]. If the solar system moves with a noticeable velocity relative to the background, the Earth's anomalous acceleration projection on the direction of this velocity will be smaller than for the Sun - because of the Earth's orbital motion. It means that in a frame of reference, connected with the Sun, the Earth should move with an anomalous acceleration having non-zero projections as well on the orbital velocity direction as on the direction of solar system motion relative to the background. Under some conditions, the Earth's anomalous acceleration in this frame of reference may be periodic. The axis of Earth's orbit should feel an annual precession by it. This question needs a further consideration.

6.4 Gravity as the screening effect

It was shown by the author [7] that screening the background of super-strong interacting gravitons creates for any pair of bodies both attraction and repulsion forces due to pressure of gravitons. For single gravitons, these forces are approximately balanced, but each of them is much bigger than a force of Newtonian attraction. If single gravitons are pairing, an attraction force due to pressure of such graviton pairs is twice exceeding a corresponding repulsion force if graviton pairs are destructed by collisions with a body. In such the model, the Newton constant is connected with the Hubble constant that gives a possibility to obtain a theoretical estimate of the last. We deal here with a flat non-expanding universe fulfilled with super-strong interacting gravitons; it changes the meaning of the Hubble constant which describes magnitudes of three small effects of quantum gravity but not any expansion or an age of the universe.

6.4.1 Pressure force of single gravitons

If gravitons of the background run against a pair of bodies with masses m_1 and m_2 (and energies E_1 and E_2) from infinity, then a part of gravitons is screened. Let $\sigma(E_1, \epsilon)$ is a cross-section of interaction of body 1 with a graviton with an energy $\epsilon = \hbar\omega$, where ω is a graviton frequency, $\sigma(E_2, \epsilon)$ is the same cross-section for body 2. In absence of body 2, a whole modulus of a gravitonic pressure force acting on body 1 would be equal to:

$$4\sigma(E_1, \langle \epsilon \rangle) \cdot \frac{1}{3} \cdot \frac{4f(\omega, T)}{c}, \quad (6.12)$$

where $f(\omega, T)$ is a graviton spectrum with a temperature T (assuming to be Planckian), the factor 4 in front of $\sigma(E_1, \langle \epsilon \rangle)$ is introduced to allow all possible directions of graviton running, $\langle \epsilon \rangle$ is another average energy of running gravitons with a frequency ω taking into account a probability of that in a realization of flat wave a number of gravitons may be equal to zero, and that not all of gravitons ride at a body.

Body 2, placed on a distance r from body 1, will screen a portion of running against body 1 gravitons which is equal for big distances between the bodies (i.e. by $\sigma(E_2, \langle \epsilon \rangle) \ll 4\pi r^2$) to:

$$\frac{\sigma(E_2, \langle \epsilon \rangle)}{4\pi r^2}. \quad (6.13)$$

Taking into account all frequencies ω , the following attractive force will act between bodies 1 and 2 :

$$F_1 = \int_0^\infty \frac{\sigma(E_2, < \epsilon >)}{4\pi r^2} \cdot 4\sigma(E_1, < \epsilon >) \cdot \frac{1}{3} \cdot \frac{4f(\omega, T)}{c} d\omega. \quad (6.14)$$

Let $f(\omega, T)$ is described with the Planck formula:

$$f(\omega, T) = \frac{\omega^2}{4\pi^2 c^2} \frac{\hbar\omega}{\exp(\hbar\omega/kT) - 1}. \quad (6.15)$$

Let $x \equiv \hbar\omega/kT$, and $\bar{n} \equiv 1/(\exp(x) - 1)$ is an average number of gravitons in a flat wave with a frequency ω (on one mode of two distinguishing with a projection of particle spin). Let $P(n, x)$ is a probability of that in a realization of flat wave a number of gravitons is equal to n , for example $P(0, x) = \exp(-\bar{n})$.

Then we get for an attractive force F_1 :

$$F_1 = \frac{4}{3} \frac{D^2 E_1 E_2}{\pi r^2 c} \int_0^\infty \frac{\hbar^3 \omega^5}{4\pi^2 c^2} (1 - P(0, x))^2 \bar{n}^5 \exp(-2\bar{n}) d\omega = \quad (6.16)$$

$$\frac{1}{3} \cdot \frac{D^2 c (kT)^6 m_1 m_2}{\pi^3 \hbar^3 r^2} \cdot I_1,$$

where

$$I_1 \equiv \int_0^\infty x^5 (1 - \exp(-(\exp(x) - 1)^{-1}))^2 (\exp(x) - 1)^{-5} \exp(-2(\exp(x) - 1)^{-1}) dx = \quad (6.17)$$

$$5.636 \cdot 10^{-3}.$$

This and all other integrals were found with the MathCad software.

If $F_1 \equiv G_1 \cdot m_1 m_2 / r^2$, then the constant G_1 is equal to:

$$G_1 \equiv \frac{1}{3} \cdot \frac{D^2 c (kT)^6}{\pi^3 \hbar^3} \cdot I_1. \quad (6.18)$$

By $T = 2.7 \text{ K}$: $G_1 = 1215.4 \cdot G$, that is three order greater than the Newton constant, G .

But if single gravitons are elastically scattered with body 1, then our reasoning may be reversed: the same portion (13) of scattered gravitons will create a repulsive force F'_1 acting on body 2 and equal to $F'_1 = F_1$, if one neglects with small allowances which are proportional to D^3/r^4 .

So, for bodies which elastically scatter gravitons, screening a flux of single gravitons does not ensure Newtonian attraction. But for gravitonic black holes which absorb any particles and do not re-emit them (by the meaning of a concept, the ones are usual black holes; I introduce a redundant adjective only from a caution), we will have $F'_1 = 0$. It means that such the object would attract other bodies with a force which is proportional to G_1 but not to G , i.e. Einstein's equivalence principle would be violated for them. This conclusion, as we shall see below, stays in force for the case of graviton pairing, too.

6.4.2 Graviton pairing

To ensure an attractive force which is not equal to a repulsive one, particle correlations should differ for *in* and *out* flux. For example, single gravitons of running flux may associate in pairs [7]. If such pairs are destructed by collision with a body, then quantities $\langle \epsilon \rangle$ will be distinguished for running and scattered particles. Graviton pairing may be caused with graviton's own gravitational attraction or gravitonic spin-spin interaction. Left an analysis of the nature of graviton pairing for the future; let us see that gives such the pairing.

To find an average number of pairs \bar{n}_2 in a wave with a frequency ω for the state of thermodynamic equilibrium, one may replace $\hbar \rightarrow 2\hbar$ by deducing the Planck formula. Then an average number of pairs will be equal to:

$$\bar{n}_2 = \frac{1}{\exp(2x) - 1}, \quad (6.19)$$

and an energy of one pair will be equal to $2\hbar\omega$. It is important that graviton pairing does not change a number of stationary waves, so as pairs nucleate from existing gravitons.

It follows from the energy conservation law that composite gravitons should be distributed only in two modes. So as

$$\lim_{x \rightarrow 0} \frac{\bar{n}_2}{\bar{n}} = 1/2, \quad (6.20)$$

then by $x \rightarrow 0$ we have $2\bar{n}_2 = \bar{n}$, i.e. all of gravitons are pairing by low frequencies. An average energy on every mode of pairing gravitons is equal to $2\hbar\omega\bar{n}_2$, the one on every mode of single gravitons - to $\hbar\omega\bar{n}$. These energies are equal by $x \rightarrow 0$, because of that, the numbers of modes are equal, too,

if the background is in the thermodynamic equilibrium with surrounding bodies.

The spectrum of composite gravitons is also the Planckian one, but with a smaller temperature of $0.5946T$. An absolute luminosity for the sub-system of composite gravitons is equal to $\frac{1}{8}\sigma T^4$, where σ is the Stephan-Boltzmann constant. It is important that the graviton pairing effect does not change computed values of the Hubble constant and of anomalous deceleration of massive bodies: twice decreasing of a sub-system particle number due to the pairing effect is compensated with twice increasing the cross-section of interaction of a photon or any body with such the composite gravitons. Non-pairing gravitons with spin 1 give also its contribution in values of redshifts, an additional relaxation of light intensity due to non-forehead collisions with gravitons, and anomalous deceleration of massive bodies moving relative to the background.

6.4.3 Computation of the Newton constant, and a connection between the two fundamental constants, G and H

If running graviton pairs ensure for two bodies an attractive force F_2 , then a repulsive force due to re-emission of gravitons of a pair alone will be equal to $F'_2 = F_2/2$. It follows from that the cross-section $\sigma(E_2, < \epsilon_2 >) = \frac{1}{2} \cdot \sigma(E_2, < \epsilon_2 >)$, where $< \epsilon_2 >$ is an average pair energy with taking into account a probability of that in a realization of flat wave a number of graviton pairs may be equal to zero, and that not all of graviton pairs ride at a body ($< \epsilon_2 >$ is an analog of $< \epsilon >$). This equality is true in neglecting with small allowances which are proportional to D^3/r^4 . Replacing $\bar{n} \rightarrow \bar{n}_2$, $\hbar\omega \rightarrow 2\hbar\omega$, and $P(n, x) \rightarrow P(n, 2x)$, where $P(0, 2x) = \exp(-\bar{n}_2)$, we get for a force of attraction of two bodies due to pressure of graviton pairs, F_2 :

$$F_2 = \int_0^\infty \frac{\sigma(E_2, < \epsilon_2 >)}{4\pi r^2} \cdot 4\sigma(E_1, < \epsilon_2 >) \cdot \frac{1}{3} \cdot \frac{4f(\omega, T)}{c} d\omega = \quad (6.21)$$

$$\frac{4}{3} \cdot \frac{D^2 c (kT)^6 m_1 m_2}{\pi^3 \hbar^3 r^2} \cdot I_2,$$

where

$$I_2 \equiv \int_0^\infty \frac{x^5 (1 - \exp(-(\exp(2x) - 1)^{-1}))^2 (\exp(2x) - 1)^{-5}}{\exp(2(\exp(x) - 1)^{-1})} dx = \quad (6.22)$$

$$2.3184 \cdot 10^{-6}.$$

The difference F between attractive and repulsive forces will be equal to:

$$F \equiv F_2 - F'_2 = \frac{1}{2}F_2 \equiv G_2 \frac{m_1 m_2}{r^2}, \quad (6.23)$$

where the constant G_2 is equal to:

$$G_2 \equiv \frac{2}{3} \cdot \frac{D^2 c (kT)^6}{\pi^3 \hbar^3} \cdot I_2. \quad (6.24)$$

Both G_1 and G_2 are proportional to T^6 (and $H \sim T^5$, so as $\bar{\epsilon} \sim T$).

If one assumes that $G_2 = G$, then it follows that by $T = 2.7K$ the constant D should have the value:

$$D = 1.124 \cdot 10^{-27} m^2 / eV^2. \quad (6.25)$$

An average graviton energy of the background is equal to:

$$\bar{\epsilon} \equiv \int_0^\infty \hbar \omega \cdot \frac{f(\omega, T)}{\sigma T^4} d\omega = \frac{15}{\pi^4} I_4 kT, \quad (6.26)$$

where

$$I_4 \equiv \int_0^\infty \frac{x^4 dx}{\exp(x) - 1} = 24.866$$

(it is $\bar{\epsilon} = 8.98 \cdot 10^{-4} eV$ by $T = 2.7K$).

We can use (8) and (24) to establish a connection between the two fundamental constants, G and H , under the condition that $G_2 = G$. We have for D :

$$D = \frac{2\pi H}{\bar{\epsilon} \sigma T^4} = \frac{2\pi^5 H}{15k\sigma T^5 I_4}; \quad (6.27)$$

then

$$G = G_2 = \frac{2}{3} \cdot \frac{D^2 c (kT)^6}{\pi^3 \hbar^3} \cdot I_2 = \frac{32\pi^5}{45} \cdot \frac{H^2 c^3 I_2}{\sigma T^4 I_4^2}. \quad (6.28)$$

So as the value of G is known much better than the value of H , let us express H via G :

$$H = \left(G \frac{45}{32\pi^5} \frac{\sigma T^4 I_4^2}{c^3 I_2} \right)^{1/2} = 3.026 \cdot 10^{-18} s^{-1}, \quad (6.29)$$

or in the units which are more familiar for many of us: $H = 94.576 km \cdot s^{-1} \cdot Mpc^{-1}$.

This value of H is significantly larger than we see in the majority of present astrophysical estimations [2, 20, 21] (for example, the estimate (72 ± 8) km/s/Mpc has been got from SN1a cosmological distance determinations in [21]), but it is well consistent with some of them [22] and with the observed value of anomalous acceleration of Pioneer 10 [1].

6.5 Some cosmological consequences of the model

If the described model of redshifts is true, what is a picture of the universe? In a frame of this model, every observer has two own spheres of observability in the universe (two different cosmological horizons exist for any observer) [23, 24]. One of them is defined by maximum existing temperatures of remote sources - by big enough distances, all of them will be masked with the CMB radiation. Another, and much smaller, sphere depends on their maximum luminosity - the luminosity distance increases with a redshift much quickly than the geometrical one. The ratio of the luminosity distance to the geometrical one is the quickly increasing function of z :

$$D_L(z)/r(z) = (1+z)^{(1+b)/2}, \quad (6.30)$$

which does not depend on the Hubble constant. An outer part of the universe will drown in a darkness.

By the found theoretical value of the Hubble constant: $H = 3.026 \cdot 10^{-18} \text{ s}^{-1}$ (then a natural light unit of distances is equal to $1/H \simeq 10.5$ light GYR), plots of two theoretical functions of z in this model - the geometrical distance $r(z)$ and the luminosity distance $D_L(z)$ - are shown on Fig. 4 [23, 24]. As one can see, for objects with $z \sim 10$, which are observable now, we should anticipate geometrical distances of the order ~ 25 light GYR and luminosity distances of the order ~ 1100 light GYR in a frame of this model. An estimate of distances to objects with given z is changed, too: for example, the quasar with $z = 5.8$ [25] should be in a distance approximately twice bigger than the one expected in the model based on the Doppler effect.

We can assume that the graviton background and the cosmic microwave one are in a state of thermodynamical equilibrium, and have the same temperatures. CMB itself may arise as a result of cooling any light radiation up to reaching this equilibrium. Then it needs $z \sim 1000$ to get through the very edge of our cosmic "ecumene".

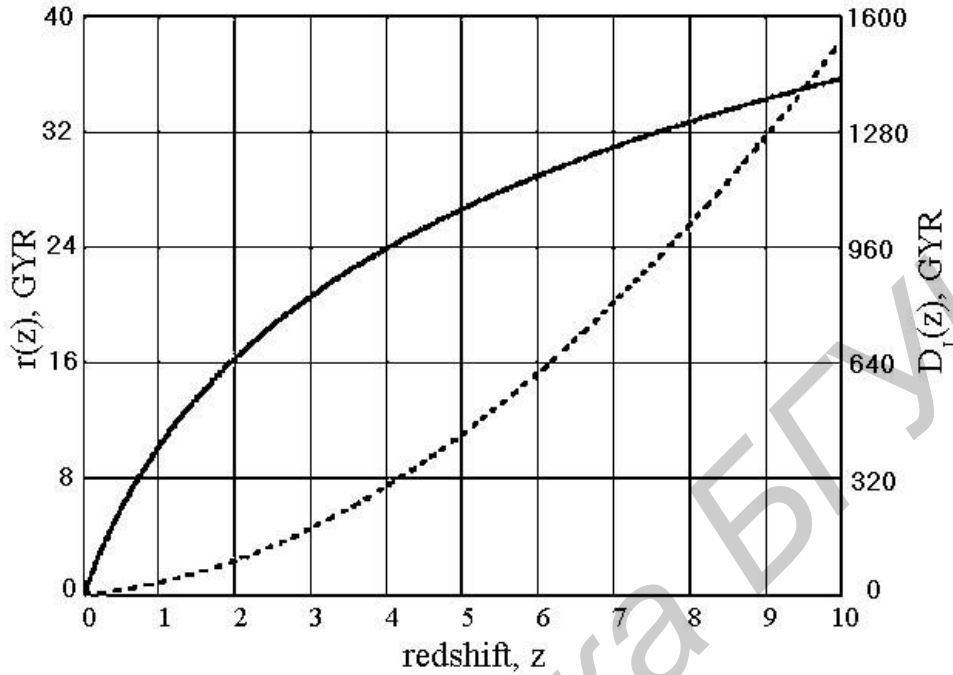

Figure 6.4: The geometrical distance, $r(z)$, (solid line) and the luminosity distance, $D_L(z)$, (dashed line) - both in light GYRs - in this model as functions of a redshift, z . The following theoretical value for H is accepted: $H = 3.026 \cdot 10^{-18} s^{-1}$.

Some other possible cosmological consequences of an existence of the graviton background were described in [26, 7]. Observations of last years give us strong evidences for supermassive and compact objects (named now supermassive black holes) in active and normal galactic nuclei [27, 28, 29, 30, 31]. Massive nuclear "black holes" of $10^6 - 10^9$ solar masses may be responsible for the energy production in quasars and active galaxies [27]. In a frame of this model, an existence of black holes contradicts to the equivalence principle. It means that these objects should have another nature; one must remember that we know only that these objects are supermassive and compact.

There should be two opposite processes of heating and cooling the graviton background [26] which may have a big impact on cosmology. Unlike models of expanding universe, in any tired light model one has a problem of utilization of energy, lost by radiation of remote objects. In the considered model, a virtual graviton forms under collision of a photon with a graviton of

the graviton background. It should be massive if an initial graviton transfers its total momentum to a photon; it follows from the energy conservation law that its energy ϵ' must be equal to 2ϵ if ϵ is an initial graviton energy. In force of the uncertainty relation, one has for a virtual graviton lifetime τ : $\tau \leq \hbar/\epsilon'$, i.e. for $\epsilon' \sim 10^{-4}$ eV it is $\tau \leq 10^{-11}$ s. In force of conservation laws for energy, momentum and angular momentum, a virtual graviton may decay into no less than three real gravitons. In a case of decay into three gravitons, its energies should be equal to ϵ , ϵ'' , ϵ''' , with $\epsilon'' + \epsilon''' = \epsilon$. So, after this decay, two new gravitons with ϵ'' , $\epsilon''' < \epsilon$ inflow into the graviton background. It is a source of adjunction of the graviton background.

From another side, an interaction of gravitons of the background between themselves should lead to the formation of virtual massive gravitons, too, with energies less than ϵ_{min} where ϵ_{min} is a minimal energy of one graviton of an initial interacting pair. If gravitons with energies ϵ'' , ϵ''' wear out a file of collisions with gravitons of the background, its lifetime increases. In every such a collision-decay cycle, an average energy of "redundant" gravitons will double decrease, and its lifetime will double increase. Only for ~ 93 cycles, a lifetime will increase from 10^{-11} s to 10 Gyr. Such virtual massive gravitons, with a lifetime increasing from one collision to another, would duly serve dark matter particles. Having a zero (or near to zero) initial velocity relative to the graviton background, the ones will not interact with matter in any manner excepting usual gravitation. An ultra-cold gas of such gravitons will condense under influence of gravitational attraction into "black holes" or other massive objects. Additionally to it, even in absence of initial heterogeneity, the one will easy arise in such the gas that would lead to arising of super compact massive objects, which will be able to turn out "germs" of "black holes". It is a method "to cool" the graviton background.

So, the graviton background may turn up "a perpetual engine" of the universe, pumping energy from any radiation to massive objects. An equilibrium state of the background will be ensured by such a temperature T , for which an energy profit of the background due to an influx of energy from radiation will be equal to a loss of its energy due to a catch of virtual massive gravitons with "black holes" or other massive objects. In such the picture, the chances are that "black holes" would turn out "germs" of galaxies. After accumulation of a big enough energy by a "black hole" (to be more exact, by a super-compact massive object) by means of a catch of virtual massive gravitons, the one would be absolved from an energy excess in via ejection of matter, from which stars of galaxy should form. It awaits to understand else

in such the approach how usual matter particles form from virtual massive gravitons.

There is a very interesting but non-researched possibility: due to relative decreasing of an intensity of graviton pair flux in an internal area of galaxies (pairs are destructed under collisions with matter particles), the effective Newton constant may turn out to be running on galactic scales. It might lead to something like to the modified Newtonian dynamics (MOND) by Mordehai Milgrom (about MOND, for example, see [32]). But to evaluate this effect, one should take into account a relaxation process for pairs, about which we know nothing today. It is obvious only that gravity should be stronger on a galactic periphery.

6.6 Conclusion

It follows from the above consideration that the geometrical description of gravity should be a good idealization for any pair of bodies at a big distance by the condition of an "atomic structure" of matter. This condition cannot be accepted only for black holes which must interact with gravitons as aggregated objects. In addition, the equivalence principle is roughly broken for black holes, if the described quantum mechanism of classical gravity is realized in the nature. Because attracting bodies are not initial sources of gravitons, a future theory must be non-local in this sense to describe gravitons running from infinity. The Le Sage's idea to describe gravity as caused by running *ab extra* particles was criticized by the great physicist Richard Feynman in his public lectures at Cornell University [33], but the Pioneer 10 anomaly [1], perhaps, is a good contra argument pro this idea.

The described quantum mechanism of classical gravity is obviously asymmetric relative to the time inversion. By the time inversion, single gravitons would run against bodies to form pairs after collisions with bodies. It would lead to replacing a body attraction with a repulsion. But such the change will do impossible the graviton pairing.

A future theory dealing with gravitons as usual particles should have a number of features which are not characterizing any existing model to image the considered here features of the possible quantum mechanism of gravity. If this mechanism is realized in the nature, both the general relativity and quantum mechanics should be modified. Any divergencies, perhaps, would be not possible in such the model because of natural smooth cut-offs of the

graviton spectrum from both sides. Gravity at short distances, which are much bigger than the Planck length, needs to be described only in some unified manner.

Библиотека БГУИР

Bibliography

- [1] Anderson, J.D. et al. *Phys. Rev. Lett.* 1998, *81*, 2858; *Phys. Rev.* 2002, *D65*, 082004; [gr-qc/0104064 v4].
- [2] Riess, A.G. et al. *AJ* 1998, *116*, 1009.
- [3] Perlmutter, S. et al. *ApJ* 1999, *517*, 565.
- [4] Nesvizhevsky, V.V. et al. *Nature* 2002, *415*, 297.
- [5] Ivanov, M.A. *General Relativity and Gravitation* 2001, *33*, 479; Erratum: 2003, *35*, 939; [astro-ph/0005084 v2] (see Chapter 1).
- [6] Ivanov, M.A. [<http://ivanovma.narod.ru/nova04.pdf>].
- [7] Ivanov, M.A. Screening the graviton background, graviton pairing, and Newtonian gravity [gr-qc/0207006] (see Chapter 3).
- [8] Hubble, E.P., and Humason, M. *ApJ*, 1931, *74*, 43.
- [9] Penzias, A.A., Wilson, R.W. *ApJ*, 1965, *142*, 419.
- [10] Smoot, G.F. *ApJ (Letters)*, 1992, *396*, L1.
- [11] LaViolette, P.A. *ApJ* 1986, *301*, 544.
- [12] Ivanov, M.A. Another origin of cosmological redshifts [astro-ph-0405083].
- [13] Riess, A.G. et al. Type Ia Supernova Discoveries at $z > 1$ From the Hubble Space Telescope ... [astro-ph/0402512] (to appear in *ApJ*, 2004).

- [14] Ivanov, M.A. Contribution to the Quantum Electronics and Laser Science Conference (QELS'95), May 21-26, 1995, Baltimore, USA; paper number: QThG1.
- [15] Murphy, M. T. et al. Time evolution of the fine structure constant [astro-ph/0209488].
- [16] Srianand, R. et al. *Nature* 2000, *408*, 931; [astro-ph/0012222].
- [17] Foley, R. J. et al. A Definitive Measurement of Time Dilation in the Spectral Evolution of the Moderate-Redshift Type Ia Supernova 1997ex [astro-ph/0504481].
- [18] Anderson, J.D., Nieto, M.M., Turyshev, S.G. *Int. J. Mod. Phys.* 2002, *D11*, 1545; [gr-qc/0205059 v3].
- [19] Turyshev, S.G. et al. XXXIV-th Rencontres de Moriond Meeting on Gravitational Waves and Experimental Gravity. Les Arcs, Savoie, France (January 23-30, 1999); [gr-qc/9903024 v2].
- [20] Freedman, W. L. et al. *ApJ* 2001, *553*, 47.
- [21] Filippenko, A.V. [astro-ph/0410609]; to be published in *White Dwarfs: Probes of Galactic Structure and Cosmology*, Sion, E. M., Shipman, H. L., Vennes, S., Eds.; Kluwer: Dordrecht.
- [22] Willick, J.A., Puneet Batra. *ApJ* 2001, *548*, 564.
- [23] Ivanov, M.A. In *Searches for a mechanism of gravity*, Ivanov, M.A., Savrov, L.A., Eds.; Nikolaev, Yu.A. Publisher: Nizhny Novgorod, 2004, pp 266-273 (in Russian).
- [24] Ivanov, M.A. A quantum gravitational model of redshifts [astro-ph/0409111].
- [25] Fan, X. et al. *AJ* 2000, *120*, 1167.
- [26] Ivanov, M.A. Model of graviton-dusty universe [gr-qc/0107047] (see Chapter 2).
- [27] van der Marel, R. P. In *New Light on Galaxy Evolution*, Proc. IAU Symp. 171, Heidelberg, June 1995, R. Bender and R.L. Davies, eds.; Kluwer Academic Publishers.

- [28] Kleijn, G. A. V. et al. *AJ* 2000, *120*, 1221.
- [29] Peterson, B. M., Wandel, A. *ApJ* 2000, *540*, L13.
- [30] Di Matteo, T., Carilli, C.L., Fabian, A.C. *ApJ* 2001, *547*, 731.
- [31] Kenji Bekki. *ApJ* 2000, *540*, L79.
- [32] Milgrom, M. In the Proceedings of the II Int. Workshop on the Identification of Dark Matter, Buxton, England, 1998; World Scientific: Singapore, 1999; [astro-ph/9810302].
- [33] Feynman, R. *The character of physical law*. Cox and Wyman Ltd.: London, 1965.

Библиотека БГУМР

Chapter 7

Low-energy quantum gravity

1

If gravitons are super-strong interacting particles and the low-temperature graviton background exists, the basic cosmological conjecture about the Dopplerian nature of redshifts may be false. In this case, a full magnitude of cosmological redshift would be caused by interactions of photons with gravitons. Non-forehead collisions with gravitons will lead to a very specific additional relaxation of any photonic flux. It gives a possibility of another interpretation of supernovae 1a data - without any kinematics. These facts may implicate a necessity to change the standard cosmological paradigm.

A quantum mechanism of classical gravity based on an existence of this sea of gravitons is described for the Newtonian limit. This mechanism needs graviton pairing and "an atomic structure" of matter for working it, and leads to the time asymmetry. If the considered quantum mechanism of classical gravity is realized in the nature, then an existence of black holes contradicts to Einstein's equivalence principle. It is shown that in this approach the two fundamental constants - Hubble's and Newton's ones - should be connected between themselves. The theoretical value of the Hubble constant is computed. In this approach, every massive body would be decelerated due to collisions with gravitons that may be connected with the Pioneer 10 anomaly. Some unsolved problems are discussed, so as possibilities to verify some conjectures in laser-based experiments.

¹Contribution to the VII Asia-Pacific International Conference on Gravitation and Astrophysics (ICGA7), Jhongli, Taiwan, 23 - 26 November 2005. [arXiv:hep-th/0510270v3]

7.1 Introduction

An opinion is commonly accepted that quantum gravity should manifest itself only on the Planck scale of energies, i.e. it is a high-energy phenomenon. The value of the Planck energy $\sim 10^{19}$ GeV has been got from dimensional reasonings. In this contribution, I would like to describe a very unexpected possibility to consider gravity as a very-low-energy stochastic process. I enumerate those discoveries and observations which may support this my opinion.

1. In 1998, Anderson's team reported about the discovery of anomalous acceleration of NASA's probes Pioneer 10/11 [1]; this effect is not embedded in a frame of the general relativity, and its magnitude is somehow equal to $\sim Hc$, where H is the Hubble constant, c is the light velocity.

2. In the same 1998, two teams of astrophysicists, which were collecting supernovae 1a data with the aim to specificate parameters of cosmological expansion, reported about dimming remote supernovae [2, 3]; the one would be explained on a basis of the Doppler effect if at present epoch the universe expands with acceleration. This explanation needs an introduction of some "dark energy" which is unknown from any laboratory experiment.

3. In January 2002, Nesvizhevsky's team reported about discovery of quantum states of ultra-cold neutrons in the Earth's gravitational field [4]. Observed energies of levels (it means that and their differences too) in full agreement with quantum-mechanical calculations turned out to be equal to $\sim 10^{-12}$ eV. If transitions between these levels are accompanied with irradiation of gravitons then energies of irradiated gravitons should have the same order - but it is of 40 orders lesser than the Planck energy.

An alternative model of redshifts [5, 6] which is based on a conjecture about an existence of the graviton background gives us odds to see on the effect of supernova dimming as an additional manifestation of low-energy quantum gravity. The main results of author's research in this approach are described here briefly (it is a short version of my summarizing paper [7]). Starting from a statistical model of the graviton background with a low temperature, it is shown - under the very important condition that gravitons are super-strong interacting particles - that if a redshift would be a quantum gravitational effect then one can get from its magnitude an estimate of a new dimensional constant characterizing a single act of interaction in this model.

7.2 Passing photons through the graviton background [5, 8]

If the isotropic graviton background exists, then it is possible photon scattering on gravitons, if one of the gravitons is virtual. Due to forehead collisions with gravitons, an energy of any photon should decrease when it passes through the sea of gravitons. From another side, none-forehead collisions of photons with gravitons of the background will lead to an additional relaxation of a photon flux, caused by transmission of a momentum transversal component to some photons. It will lead to an additional dimming of any remote objects, and may be connected with supernova dimming. We deal here with the uniform non-expanding universe with the Euclidean space, and there are not any cosmological kinematic effects in this model. We shall take into account that a gravitational "charge" of a photon must be proportional to E (it gives the factor E^2 in a cross-section) and a normalization of a photon wave function gives the factor E^{-1} in the cross-section. Also we assume here that a photon average energy loss $\bar{\epsilon}$ in one act of interaction is relatively small to a photon energy E . Then average energy losses of a photon with an energy E on a way dr will be equal to [5, 8]:

$$dE = -aE dr, \quad (7.1)$$

where a is a constant. If a *whole* redshift magnitude is caused by this effect, we must identify $a = H/c$, where c is the light velocity, to have the Hubble law for small distances. The expression (1) is true if the condition $\bar{\epsilon} \ll E(r)$ takes place. Photons with a very small energy may lose or acquire an energy changing their direction of propagation after scattering. Early or late such photons should turn out in the thermodynamic equilibrium with the graviton background, flowing into their own background. Perhaps, the last one is the cosmic microwave background.

Photon flux's average energy losses on a way dr due to non-forehead collisions with gravitons should be proportional to $badr$, where b is a new constant of the order 1. These losses are connected with a rejection of a part of photons from a source-observer direction. We get for the factor b (see [9]):

$$b = \frac{4}{\pi} \left(\int_0^{\pi/4} 2 \cos^2 \theta d\theta + \int_{\pi/4}^{\pi/2} \sin^2 2\theta d\theta \right) = \frac{3}{2} + \frac{2}{\pi} \simeq 2.137. \quad (7.2)$$

Both redshifts and the additional relaxation of any photonic flux due to non-forehead collisions of gravitons with photons lead in our model to the

7.2. PASSING PHOTONS THROUGH THE GRAVITON BACKGROUND 87

following luminosity distance D_L :

$$D_L = a^{-1} \ln(1+z) \cdot (1+z)^{(1+b)/2} \equiv a^{-1} f_1(z), \quad (7.3)$$

where $f_1(z) \equiv \ln(1+z) \cdot (1+z)^{(1+b)/2}$.

To compare a form of this predicted dependence $D_L(z)$ by unknown, but constant H , with the latest observational supernova data by Riess et al. [10], we can use the fact that f_1 is the luminosity distance in units of c/H . In Figure 1, the graph of f_1 is shown; observational data (82 points) are taken from Table 5 of [10]. Observations of [10] are transformed as $\mu_0 \rightarrow 10^{(\mu_0 - c_1)/5}$ with the constant $c_1 = 43$. The predictions fit observations very well for roughly $z < 0.5$. It excludes a need of any dark energy to explain supernova dimming. Discrepancies between predicted and observed values of $\mu_0(z)$ are obvious for higher z : we see that observations show brighter SNe than the theory allows, and a difference increases with z . It would be explained in

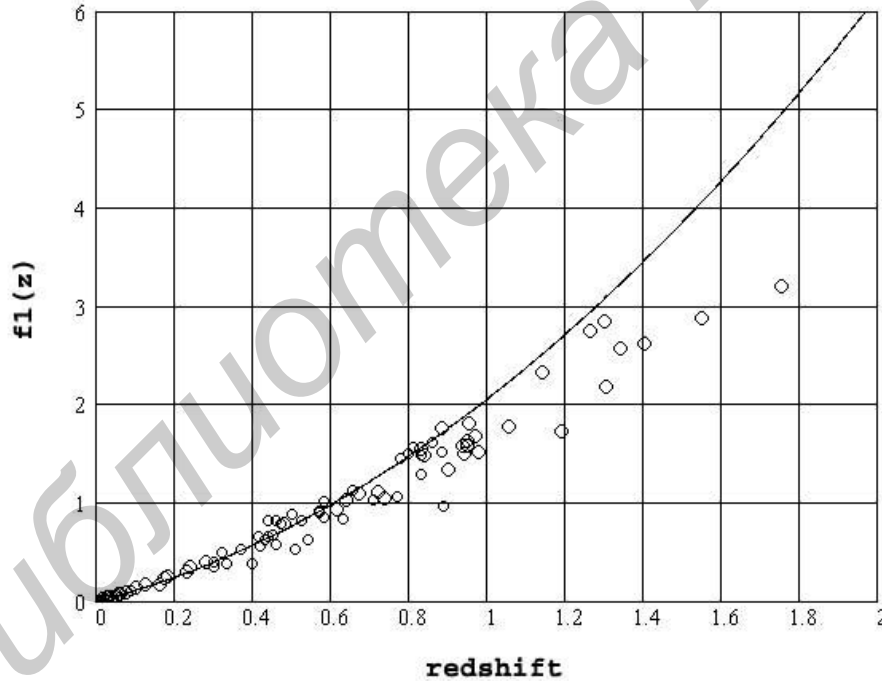

Figure 7.1: Predicted values of $f_1(z)$ (solid line) and observations (points) from [10] transformed to a linear scale

the model as a result of specific deformation of SN spectra due to a discrete

character of photon energy losses. Today, a theory of this effect does not exist.

In this model, the Hubble constant may be computed. Let us consider that a full redshift magnitude is caused by an interaction with single gravitons, and $\sigma(E, \epsilon)$ is a cross-section of interaction by forehead collisions of a photon with an energy E with a graviton, having an energy ϵ . Let us introduce a new dimensional constant D , so that for forehead collisions:

$$\sigma(E, \epsilon) = D \cdot E \cdot \epsilon. \quad (7.4)$$

Then

$$H = \frac{1}{2\pi} D \cdot \bar{\epsilon} \cdot (\sigma T^4), \quad (7.5)$$

where $\bar{\epsilon}$ is an average graviton energy. Assuming $T \sim 3K$, $\bar{\epsilon} \sim 10^{-4} eV$, and $H = 1.6 \cdot 10^{-18} s^{-1}$, we get the following rough estimate for D : $D \sim 10^{-27} m^2/eV^2$, that gives us the phenomenological estimate of cross-section by the same and equal E and $\bar{\epsilon}$: $\sigma(E, \bar{\epsilon}) \sim 10^{-35} m^2$.

It follows from a universality of gravitational interaction, that not only photons, but all other objects, moving relative to the background, should lose their energy, too, due to such a quantum interaction with gravitons. If $a = H/c$, it turns out that massive bodies must feel a constant deceleration of the same order of magnitude as a small additional acceleration of NASA cosmic probes (the Pioneer anomaly). We get for the body acceleration $w \equiv dv/dt$ by a non-zero velocity:

$$w = -ac^2(1 - v^2/c^2). \quad (7.6)$$

For small velocities: $w \simeq -Hc$. If the Hubble constant H is equal to $2.14 \cdot 10^{-18} s^{-1}$ (it is the theoretical estimate of H in this approach), a modulus of the acceleration will be equal to $|w| = 6.419 \cdot 10^{-10} m/s^2$, that has the same order of magnitude as a value of the observed additional acceleration $(8.74 \pm 1.33) \cdot 10^{-10} m/s^2$ for NASA probes [1].

7.3 Gravity as the screening effect

It was shown by the author [8, 11, 12] that screening the background of super-strong interacting gravitons creates for any pair of bodies both attraction and repulsion forces due to pressure of gravitons. For single gravitons, these forces

are approximately balanced, but each of them is much bigger than a force of Newtonian attraction. If single gravitons are pairing, an attraction force due to pressure of such graviton pairs is twice exceeding a corresponding repulsion force if graviton pairs are destructed by collisions with a body. In such the model, the Newton constant is connected with the Hubble constant that gives a possibility to obtain a theoretical estimate of the last. We deal here with a flat non-expanding universe fulfilled with super-strong interacting gravitons; it changes the meaning of the Hubble constant which describes magnitudes of three small effects of quantum gravity but not any expansion or an age of the universe.

7.3.1 Pressure force of single gravitons

If masses of two bodies are m_1 and m_2 (and energies E_1 and E_2), $\sigma(E_1, \epsilon)$ is a cross-section of interaction of body 1 with a graviton with an energy $\epsilon = \hbar\omega$, where ω is a graviton frequency, $\sigma(E_2, \epsilon)$ is the same cross-section for body 2. Then the following attractive force will act between bodies 1 and 2 :

$$F_1 = \int_0^\infty \frac{\sigma(E_2, \langle \epsilon \rangle)}{4\pi r^2} \cdot 4\sigma(E_1, \langle \epsilon \rangle) \cdot \frac{1}{3} \cdot \frac{4f(\omega, T)}{c} d\omega. \quad (7.7)$$

If $f(\omega, T)$ is described with the Planck formula, and $\bar{n} \equiv 1/(\exp(x) - 1)$ is an average number of gravitons in a flat wave with a frequency ω (on one mode of two distinguishing with a projection of particle spin), $P(n, x)$ is a probability of that in a realization of flat wave a number of gravitons is equal to n , we shall have for $\langle \epsilon \rangle$ the following expression (for more details, see [7]):

$$\langle \epsilon \rangle = \hbar\omega(1 - P(0, x))\bar{n}^2 \exp(-\bar{n}). \quad (7.8)$$

A quantity $\langle \epsilon \rangle$ is another average energy of running gravitons with a frequency ω taking into account a probability of that in a realization of flat wave a number of gravitons may be equal to zero, and that not all of gravitons ride at a body. Then an attractive force F_1 will be equal to:

$$\begin{aligned} F_1 &= \frac{4}{3} \frac{D^2 E_1 E_2}{\pi r^2 c} \int_0^\infty \frac{\hbar^3 \omega^5}{4\pi^2 c^2} (1 - P(0, x))^2 \bar{n}^5 \exp(-2\bar{n}) d\omega \quad (7.9) \\ &= \frac{1}{3} \cdot \frac{D^2 c (kT)^6 m_1 m_2}{\pi^3 \hbar^3 r^2} \cdot I_1, \end{aligned}$$

where $I_1 = 5.636 \cdot 10^{-3}$. When $F_1 \equiv G_1 \cdot m_1 m_2 / r^2$, the constant G_1 is equal to:

$$G_1 \equiv \frac{1}{3} \cdot \frac{D^2 c (kT)^6}{\pi^3 \hbar^3} \cdot I_1. \quad (7.10)$$

By $T = 2.7 \text{ K}$: $G_1 = 1215.4 \cdot G$, that is three order greater than the Newton constant, G .

But if single gravitons are elastically scattered with body 1, then our reasoning may be reversed: the same portion of scattered gravitons will create a repulsive force F'_1 acting on body 2 and equal to $F'_1 = F_1$. So, for bodies which elastically scatter gravitons, screening a flux of single gravitons does not ensure Newtonian attraction. But for black holes which absorb any particles and do not re-emit them, we will have $F'_1 = 0$. It means that such the object would attract other bodies with a force which is proportional to G_1 but not to G , i.e. Einstein's equivalence principle would be violated for them. This conclusion stays in force for the case of graviton pairing, too.

7.3.2 Graviton pairing

To ensure an attractive force which is not equal to a repulsive one, particle correlations should differ for *in* and *out* flux. For example, single gravitons of running flux may associate in pairs [8]. If such pairs are destructed by collision with a body, then quantities $\langle \epsilon \rangle$ will be distinguished for running and scattered particles. Graviton pairing may be caused with graviton's own gravitational attraction or gravitonic spin-spin interaction. Left an analysis of the nature of graviton pairing for the future; let us see that gives such the pairing.

To find an average number of pairs \bar{n}_2 in a wave with a frequency ω for the state of thermodynamic equilibrium, one may replace $\hbar \rightarrow 2\hbar$ by deducing the Planck formula. Then an average number of pairs will be equal to:

$$\bar{n}_2 = \frac{1}{\exp(2x) - 1}, \quad (7.11)$$

and an energy of one pair will be equal to $2\hbar\omega$. It is important that graviton pairing does not change a number of stationary waves, so as pairs nucleate from existing gravitons. The question arises: how many different modes, i.e. spin projections, may graviton pairs have? We assume here that the background of initial gravitons consists of two modes. For massless transverse bosons, it takes place as by spin 1 as by spin 2. If graviton pairs have

maximum spin 2, then single gravitons should have spin 1. But from such particles one may constitute four combinations: $\uparrow\uparrow$, $\downarrow\downarrow$ (with total spin 2), and $\uparrow\downarrow$, $\downarrow\uparrow$ (with total spin 0). All these four combinations will be equiprobable if spin projections \uparrow and \downarrow are equiprobable in a flat wave (without taking into account a probable spin-spin interaction).

But it follows from the energy conservation law that composite gravitons should be distributed only in two modes. So as

$$\lim_{x \rightarrow 0} \frac{\bar{n}_2}{\bar{n}} = 1/2, \quad (7.12)$$

then by $x \rightarrow 0$ we have $2\bar{n}_2 = \bar{n}$, i.e. all of gravitons are pairing by low frequencies. An average energy on every mode of pairing gravitons is equal to $2\hbar\omega\bar{n}_2$, the one on every mode of single gravitons - to $\hbar\omega\bar{n}$. These energies are equal by $x \rightarrow 0$, because of that, the numbers of modes are equal, too, if the background is in the thermodynamic equilibrium with surrounding bodies. The above reasoning does not allow to choose a spin value 2 or 0 for composite gravitons. A choice of namely spin 2 would ensure the following proposition: all of gravitons in one realization of flat wave have the same spin projections. From another side, a spin-spin interaction would cause it.

The spectrum of composite gravitons is also the Planckian one, but with a smaller temperature $T_2 \equiv (1/8)^{1/4}T = 0.5946 T$.

It is important that the graviton pairing effect does not change computed values of the Hubble constant and of anomalous deceleration of massive bodies: twice decreasing of a sub-system particle number due to the pairing effect is compensated with twice increasing the cross-section of interaction of a photon or any body with such the composite gravitons. Non-pairing gravitons with spin 1 give also its contribution in values of redshifts, an additional relaxation of light intensity due to non-forehead collisions with gravitons, and anomalous deceleration of massive bodies moving relative to the background.

7.3.3 Computation of the Newton constant, and a connection between the two fundamental constants, G and H

If running graviton pairs ensure for two bodies an attractive force F_2 , then a repulsive force due to re-emission of gravitons of a pair alone will be equal to $F'_2 = F_2/2$. It follows from that the cross-section for *single additional*

scattered gravitons of destructed pairs will be twice smaller than for pairs themselves (the leading factor $2\hbar\omega$ for pairs should be replaced with $\hbar\omega$ for single gravitons). For pairs, we introduce here the cross-section $\sigma(E_2, < \epsilon_2 >)$, where $< \epsilon_2 >$ is an average pair energy with taking into account a probability of that in a realization of flat wave a number of graviton pairs may be equal to zero, and that not all of graviton pairs ride at a body ($< \epsilon_2 >$ is an analog of $< \epsilon >$). Replacing $\bar{n} \rightarrow \bar{n}_2$, $\hbar\omega \rightarrow 2\hbar\omega$, and $P(n, x) \rightarrow P(n, 2x)$, where $P(0, 2x) = \exp(-\bar{n}_2)$, we get for graviton pairs:

$$< \epsilon_2 > \sim 2\hbar\omega(1 - P(0, 2x))\bar{n}_2^2 \exp(-\bar{n}_2). \quad (7.13)$$

This expression does not take into account only that beside pairs there may be single gravitons in a realization of flat wave. To reject cases when, instead of a pair, a single graviton runs against a body (a contribution of such gravitons in attraction and repulsion is the same), we add the factor $P(0, x)$ into $< \epsilon_2 >$:

$$< \epsilon_2 > = 2\hbar\omega(1 - P(0, 2x))\bar{n}_2^2 \exp(-\bar{n}_2) \cdot P(0, x). \quad (7.14)$$

Then a force of attraction of two bodies due to pressure of graviton pairs, F_2 , - in the full analogy with (19) - will be equal to²:

$$F_2 = \int_0^\infty \frac{\sigma(E_2, < \epsilon_2 >)}{4\pi r^2} \cdot 4\sigma(E_1, < \epsilon_2 >) \cdot \frac{1}{3} \cdot \frac{4f_2(2\omega, T)}{c} d\omega = \quad (7.15)$$

$$\frac{8}{3} \cdot \frac{D^2 c (kT)^6 m_1 m_2}{\pi^3 \hbar^3 r^2} \cdot I_2,$$

where $I_2 = 2.3184 \cdot 10^{-6}$. The difference F between attractive and repulsive forces will be equal to:

$$F \equiv F_2 - F'_2 = \frac{1}{2} F_2 \equiv G_2 \frac{m_1 m_2}{r^2}, \quad (7.16)$$

where the constant G_2 is equal to:

$$G_2 \equiv \frac{4}{3} \cdot \frac{D^2 c (kT)^6}{\pi^3 \hbar^3} \cdot I_2. \quad (7.17)$$

Both G_1 and G_2 are proportional to T^6 (and $H \sim T^5$, so as $\bar{\epsilon} \sim T$).

²In initial version of this paper, factor 2 was lost in the right part of Eq. (15), and the theoretical values of D and H were overestimated of $\sqrt{2}$ times

If one assumes that $G_2 = G$, then it follows from (17) that by $T = 2.7K$ the constant D should have the value: $D = 0.795 \cdot 10^{-27} m^2/eV^2$.

We can use (5) and (17) to establish a connection between the two fundamental constants, G and H , under the condition that $G_2 = G$. We have for D :

$$D = \frac{2\pi H}{\bar{\epsilon}\sigma T^4} = \frac{2\pi^5 H}{15k\sigma T^5 I_4}; \quad (7.18)$$

then

$$G = G_2 = \frac{4}{3} \cdot \frac{D^2 c (kT)^6}{\pi^3 \hbar^3} \cdot I_2 = \frac{64\pi^5}{45} \cdot \frac{H^2 c^3 I_2}{\sigma T^4 I_4^2}. \quad (7.19)$$

So as the value of G is known much better than the value of H , let us express H via G :

$$H = \left(G \frac{45}{64\pi^5} \frac{\sigma T^4 I_4^2}{c^3 I_2} \right)^{1/2} = 2.14 \cdot 10^{-18} s^{-1}, \quad (7.20)$$

or in the units which are more familiar for many of us: $H = 66.875 km \cdot s^{-1} \cdot Mpc^{-1}$.

This value of H is in the good accordance with the majority of present astrophysical estimations [2, 13, 14] (for example, the estimate (72 ± 8) km/s/Mpc has been got from SN1a cosmological distance determinations in [14]), but it is lesser than some of them [15] and than it follows from the observed value of anomalous acceleration of Pioneer 10 [1].

7.3.4 Restrictions on a geometrical language in gravity

The described quantum mechanism of classical gravity gives Newton's law with the constant G_2 value (17) and the connection (19) for the constants G_2 and H . We have obtained the rational value of H (20) by $G_2 = G$, if the condition of big distances is fulfilled:

$$\sigma(E_2, < \epsilon >) \ll 4\pi r^2. \quad (7.21)$$

Because it is known from experience that for big bodies of the solar system, Newton's law is a very good approximation, one would expect that this condition is fulfilled, for example, for the pair Sun-Earth. But assuming $r = 1 AU$ and $E_2 = m_{\odot} c^2$, we obtain assuming for rough estimation $< \epsilon > \rightarrow \bar{\epsilon}$:

$$\frac{\sigma(E_2, < \epsilon >)}{4\pi r^2} \sim 4 \cdot 10^{12}.$$

It means that in the case of interaction of gravitons or graviton pairs with the Sun in the aggregate, the considered quantum mechanism of classical gravity could not lead to Newton's law as a good approximation. This "contradiction" with experience is eliminated if one assumes that gravitons interact with "small particles" of matter - for example, with atoms. If the Sun contains of N atoms, then $\sigma(E_2, < \epsilon >) = N\sigma(E_a, < \epsilon >)$, where E_a is an average energy of one atom. For rough estimation we assume here that $E_a = E_p$, where E_p is a proton rest energy; then it is $N \sim 10^{57}$, i.e. $\sigma(E_a, < \epsilon >)/4\pi r^2 \sim 10^{-45} \ll 1$.

This necessity of "atomic structure" of matter for working the described quantum mechanism is natural relative to usual bodies. But would one expect that black holes have a similar structure? If any radiation cannot be emitted with a black hole, a black hole should interact with gravitons as an aggregated object, i.e. this condition for a black hole of sun mass has not been fulfilled even at distances $\sim 10^6$ AU.

For bodies without an atomic structure, the allowances, which are proportional to D^3/r^4 and are caused by decreasing a gravitonic flux due to the screening effect, will have a factor $m_1^2 m_2$ or $m_1 m_2^2$. These allowances break the equivalence principle for such the bodies.

For bodies with an atomic structure, a force of interaction is added up from small forces of interaction of their "atoms":

$$F \sim N_1 N_2 m_a^2 / r^2 = m_1 m_2 / r^2,$$

where N_1 and N_2 are numbers of atoms for bodies 1 and 2. The allowances to full forces due to the screening effect will be proportional to the quantity: $N_1 N_2 m_a^3 / r^4$, which can be expressed via the full masses of bodies as $m_1^2 m_2 / r^4 N_1$ or $m_1 m_2^2 / r^4 N_2$. By big numbers N_1 and N_2 the allowances will be small. The allowance to the force F , acting on body 2, will be equal to:

$$\begin{aligned} \Delta F &= \frac{1}{2N_2} \int_0^\infty \frac{\sigma^2(E_2, < \epsilon_2 >)}{(4\pi r^2)^2} \cdot 4\sigma(E_1, < \epsilon_2 >) \cdot \frac{1}{3} \cdot \frac{4f_2(2\omega, T)}{c} d\omega \quad (7.22) \\ &= \frac{2}{3N_2} \cdot \frac{D^3 c^3 (kT)^7 m_1 m_2^2}{\pi^4 \hbar^3 r^4} \cdot I_3, \end{aligned}$$

(for body 1 we shall have the similar expression if replace $N_2 \rightarrow N_1$, $m_1 m_2^2 \rightarrow m_1^2 m_2$), where $I_3 = 1.0988 \cdot 10^{-7}$.

Let us find the ratio:

$$\frac{\Delta F}{F} = \frac{DE_2 kT}{N_2 2\pi r^2} \cdot \frac{I_3}{I_2}. \quad (7.23)$$

Using this formula, we can find by $E_2 = E_\odot$, $r = 1 \text{ AU}$:

$$\frac{\Delta F}{F} \sim 10^{-46}. \quad (7.24)$$

An analogical allowance to the force F_1 has by the same conditions the order $\sim 10^{-48} F_1$, or $\sim 10^{-45} F$. One can replace E_p with a rest energy of very big atom - the geometrical approach will left a very good language to describe the solar system. We see that for bodies with an atomic structure the considered mechanism leads to very small deviations from Einstein's equivalence principle, if the condition of big distances is fulfilled for microparticles, which prompt interact with gravitons.

For small distances we shall have:

$$\sigma(E_2, < \epsilon >) \sim 4\pi r^2. \quad (7.25)$$

It takes place by $E_a = E_p$, $< \epsilon > \sim 10^{-3} \text{ eV}$ for $r \sim 10^{-11} \text{ m}$. This quantity is many orders larger than the Planck length. The equivalence principle should be broken at such distances.

7.4 Some cosmological consequences of the model

If the described model of redshifts is true, what is a picture of the universe? It is interesting that in a frame of this model, every observer has two own spheres of observability in the universe (two different cosmological horizons exist for any observer) [16, 17]. One of them is defined by maximum existing temperatures of remote sources - by big enough distances, all of them will be masked with the CMB radiation. Another, and much smaller, sphere depends on their maximum luminosity - the luminosity distance increases with a redshift much quickly than the geometrical one. The ratio of the luminosity distance to the geometrical one is the quickly increasing function of z : $D_L(z)/r(z) = (1+z)^{(1+b)/2}$, which does not depend on the Hubble constant. An outer part of the universe will drown in a darkness. We can assume that the graviton background and the cosmic microwave one are in a state of thermodynamical equilibrium, and have the same temperatures. CMB itself may arise as a result of cooling any light radiation up to reaching this equilibrium. Then it needs $z \sim 1000$ to get through the very edge of

our cosmic "ecumene". Some other possible cosmological consequences of an existence of the graviton background were described in [18, 8].

The graviton background may turn up "a perpetual engine" of the universe, pumping energy from any radiation to massive objects. An equilibrium state of the background will be ensured by such a temperature T , for which an energy profit of the background due to an influx of energy from radiation will be equal to a loss of its energy due to a catch of virtual massive gravitons with "black holes" or other massive objects. In such the picture, the chances are that "black holes" would turn out "germs" of galaxies. After accumulation of a big enough energy by a "black hole" (to be more exact, by a super-compact massive object) by means of a catch of virtual massive gravitons, the one would be absolved from an energy excess in via ejection of matter, from which stars of galaxy should form. It awaits to understand else in such the approach how usual matter particles form from virtual massive gravitons.

There is a very interesting but non-researched possibility: due to relative decreasing of an intensity of graviton pair flux in an internal area of galaxies (pairs are destructed under collisions with matter particles), the effective Newton constant may turn out to be running on galactic scales. It might lead to something like to the modified Newtonian dynamics (MOND) by Mordehai Milgrom (about MOND, for example, see [19]). But to evaluate this effect, one should take into account a relaxation process for pairs, about which we know nothing today. It is obvious only that gravity should be stronger on a galactic periphery. The renormalization group approach to gravity leads to modifications of the theory of general relativity on galactic scales [20, 21], and a growth of Newton's constant at large distances takes place, too. Kepler's third law receives quantum corrections that may explain the flat rotation curves of the galaxies.

7.5 How to verify the main conjecture of this approach in a laser experiment on the Earth

I would like to show here (see [22, 7]) a full realizability at present time of verifying my basic conjecture about the quantum gravitational nature of redshifts in a ground-based laser experiment. Of course, many details of this

precision experiment will be in full authority of experimentalists.

It was not clear in 1995 how big is a temperature of the graviton background, and my proposal [23] to verify the conjecture about the described local quantum character of redshifts turned out to be very rigid: a laser with instability of $\sim 10^{-17}$ hasn't appeared after 10 years. But if $T = 2.7K$, the satellite of main laser line of frequency ν after passing the delay line will be red-shifted at $\sim 10^{-3}$ eV/h and its position will be fixed (see Fig. 2). It will be caused by the fact that on a very small way in the delay line only a

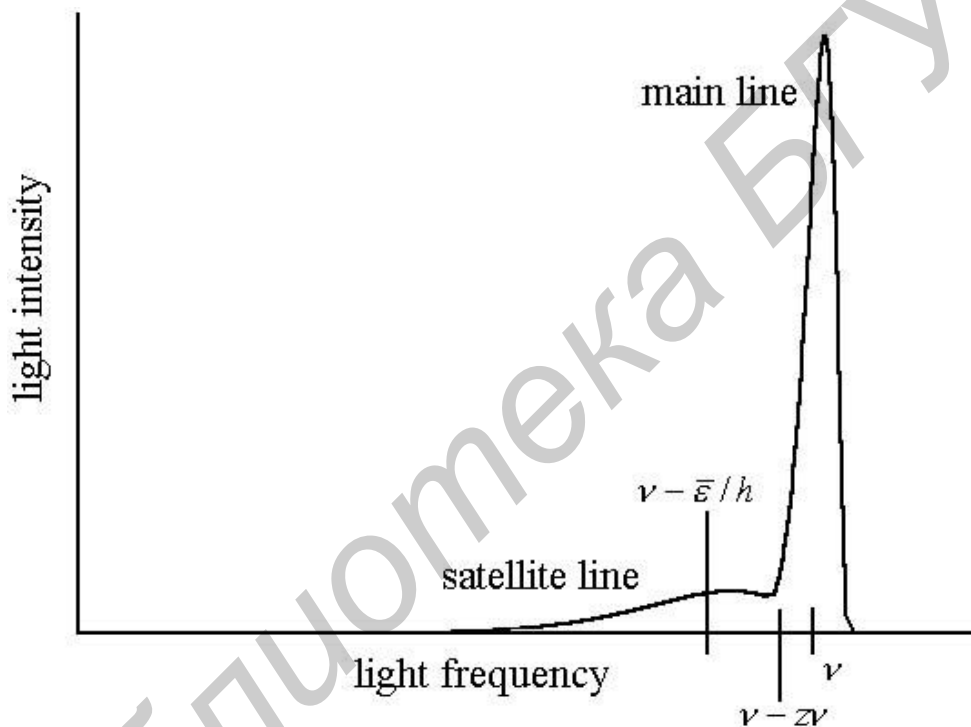

Figure 7.2: The main line and the expected red-shifted satellite line of a stable laser radiation spectrum after a delay line. Satellite's position should be fixed near $\nu - \bar{\epsilon}/h$, and its intensity should linear rise with a path of photons in a delay line, l . A center-of-mass of both lines is expected to be approximately near $\nu - z\nu$.

small part of photons may collide with gravitons of the background. The rest of them will have unchanged energies. The center-of-mass of laser radiation spectrum should be shifted proportionally to a photon path. Then due to

the quantum nature of shifting process, the ratio of satellite's intensity to main line's intensity should have the order: $\sim \frac{h\nu}{\epsilon} \frac{H}{c} l$, where l is a path of laser photons in a vacuum tube of delay line. It gives us a possibility to plan a laser-based experiment to verify the basic conjecture of this approach with much softer demands to the equipment. An instability of a laser of a power P must be only $\ll 10^{-3}$ if a photon energy is of ~ 1 eV. It will be necessary to compare intensities of the red-shifted satellite at the very beginning of the path l and after it. Given a very low signal-to-noise ratio, one could use a single photon counter to measure the intensities. When q is a quantum output of a cathode of the used photomultiplier (a number of photoelectrons is q times smaller than a number of photons falling to the cathode), N_n is a frequency of its noise pulses, and n is a desired ratio of a signal to noise's standard deviation, then an evaluated time duration t of data acquisition would have the order:

$$t = \frac{\epsilon^2 c^2}{H^2} \frac{n^2 N_n}{q^2 P^2 l^2}. \quad (7.26)$$

Assuming $n = 10$, $N_n = 10^3$ s⁻¹, $q = 0.3$, $P = 100$ mW, $l = 100$ m, we would have the estimate: $t = 200,000$ years, that is unacceptable. But given $P = 300$ W, we get: $t \sim 8$ days, that is acceptable for the experiment of such the potential importance. Of course, one will rather choose a bigger value of l by a small laser power forcing a laser beam to whipsaw many times between mirrors in a delay line - it is a challenge for experimentalists.

7.6 Gravity in a frame of non-linear and non-local QED? - the question only to the Nature

From thermodynamic reasons, it is assumed here that the graviton background has the same temperature as the microwave background. Also it follows from the condition of detail equilibrium, that both backgrounds should have the Planckian spectra. Composite gravitons will have spin 2, if single gravitons have the same spin as photons. The question arise, of course: how are gravitons and photons connected? Has the conjecture by Adler et al. [24, 25] (that a graviton with spin 2 is composed with two photons) chances to be true? Intuitive demur calls forth a huge self-action, photons should be endowed with which if one unifies the main conjecture of this approach with

the one by Adler et al. - but one may get a unified theory on this way.

To verify this combined conjecture in experiment, one would search for transitions in interstellar gas molecules caused by the microwave background, with an angular momentum change corresponding to absorption of spin 2 particles (photon pairs). A frequency of such the transitions should correspond to an equivalent temperature of the sub-system of these composite particles $T_2 = 0.5946 T$, if T is a temperature of the microwave background.

From another side, one might check this conjecture in a laser experiment, too (see [26, 7]). Taking two lasers with photon energies $h\nu_1$ and $h\nu_2$, one may force laser beams to collide on a way L (see Fig. 3). If photons are self-interacting particles, we might wait that photons with energies $h\nu_1 - h\nu_2$, if $h\nu_1 > h\nu_2$, would arise after collisions of initial photons. If we *assume (only*

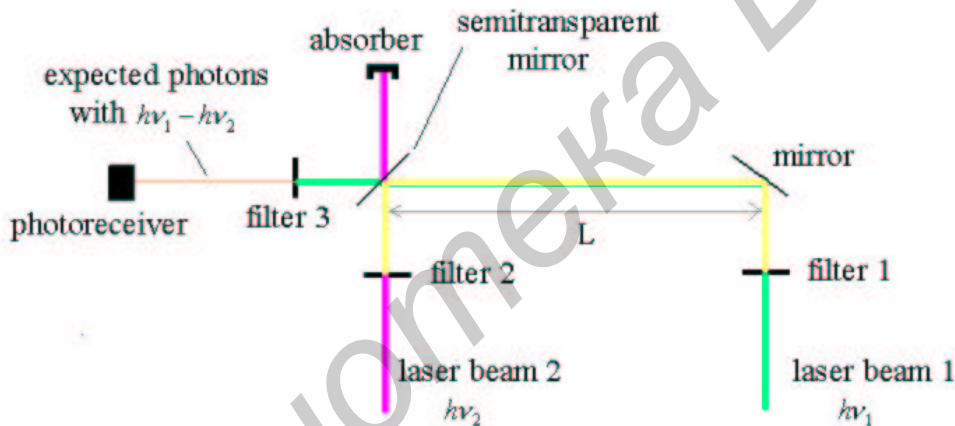

Figure 7.3: The scheme of laser beam passes. Two laser beams 1 and 2 collide into the area with a length L . An expected beam of photons with energies $h\nu_1 - h\nu_2$ falls to a photoreceiver.

here) that single gravitons are identical to photons, it will be necessary to take into account the following circumstances to calculate an analog of the Hubble constant for this experiment: an average graviton energy should be replaced with $h\nu_2$, the factor $1/2\pi$ in (5) should be replaced with $1/\varphi$, where φ is a divergence of laser beam 2, and one must use a quantity P/S instead of σT^4 in (5), where P is a laser 2 power and S is a cross-section of its beam. Together all it means that we should replace the Hubble constant with its

analog for a laser beam collision, H_{laser} :

$$H \rightarrow H_{laser} = \frac{1}{\varphi} \cdot D \cdot h\nu_2 \cdot \frac{P}{S}. \quad (7.27)$$

Taken $\varphi = 10^{-4}$, $h\nu_2 \sim 1 \text{ eV}$, $P \sim 10 \text{ mW}$, and $P/S \sim 10^3 \text{ W/m}^2$, that is characterizing a He-Ne laser, we get the estimate: $H_{laser} \sim 0.06 \text{ s}^{-1}$. Then photons with energies $h\nu_1 - h\nu_2$ would fall to a photoreceiver with a frequency which should linearly rise with L (proportionally to $\frac{H_{laser}}{c} \cdot L$), and it would be of 10^7 s^{-1} if both lasers have equal powers $\sim 10 \text{ mW}$, and $L \sim 1 \text{ m}$. It is a big enough frequency to give us a possibility to detect easy a flux of these expected photons in IR band.

If this tentative non-linear vacuum effect exists, it would lead us far beyond standard quantum electrodynamics to take into account new nonlinearities (which are not connected with the electron-positron pair creation) and an essential impact of such a non-locally born object as the graviton background.

7.7 Conclusion

It follows from the above consideration that the geometrical description of gravity should be a good idealization for any pair of bodies at a big distance by the condition of an "atomic structure" of matter. This condition cannot be accepted only for black holes which must interact with gravitons as aggregated objects. In addition, the equivalence principle is roughly broken for black holes, if the described quantum mechanism of classical gravity is realized in the nature. Because attracting bodies are not initial sources of gravitons, a future theory must be non-local in this sense to describe gravitons running from infinity. The described quantum mechanism of classical gravity is obviously asymmetric relative to the time inversion. By the time inversion, single gravitons would run against bodies to form pairs after collisions with bodies. It would lead to replacing a body attraction with a repulsion. But such the change will do impossible the graviton pairing. Cosmological models with the inversion of the time arrow were considered by Sakharov [27]. Penrose has noted that a hidden physical law may determine the time arrow direction [28]; it will be very interesting if namely realization in the nature of Newton's law determines this direction.

A future theory dealing with gravitons as usual particles should have a number of features which are not characterizing any existing model to image the considered here features of the possible quantum mechanism of gravity. If this mechanism is realized in the nature, both the general relativity and quantum mechanics should be modified. Any divergencies, perhaps, would be not possible in such the model because of natural smooth cut-offs of the graviton spectrum from both sides. Gravity at short distances, which are much bigger than the Planck length, needs to be described only in some unified manner.

Библиотека БГУИР

Bibliography

- [1] Anderson, J.D. et al. *Phys. Rev. Lett.* 1998, *81*, 2858; *Phys. Rev.* 2002, *D65*, 082004; [gr-qc/0104064 v4].
- [2] Riess, A.G. et al. *AJ* 1998, *116*, 1009.
- [3] Perlmutter, S. et al. *ApJ* 1999, *517*, 565.
- [4] Nesvizhevsky, V.V. et al. *Nature* 2002, *415*, 297.
- [5] Ivanov, M.A. *General Relativity and Gravitation* 2001, *33*, 479; Erratum: 2003, *35*, 939; [astro-ph/0005084 v2] (see Chapter 1).
- [6] Ivanov, M.A. [gr-qc/0009043]; Proc. of the Int. Symp. "Frontiers of Fundamental Physics 4" (9-13 Dec 2000, Hyderabad, India), Sidharth, B.G., Altaisky, M.V., Eds.; Kluwer Academic/Plenum Publishers: August 2001; Proc. of the 4th Edoardo Amaldi Conference on Gravitational Waves (Perth, Western Australia, 8-13 July 2001) *Class. Quantum Grav.* 2002, *19*, 1351.
- [7] Ivanov, M.A. Gravitons as super-strong interacting particles, and low-energy quantum gravity [hep-th/0506189], [<http://ivanovma.narod.ru/nova04.pdf>].
- [8] Ivanov, M.A. Screening the graviton background, graviton pairing, and Newtonian gravity [gr-qc/0207006] (see Chapter 3).
- [9] Ivanov, M.A. Another origin of cosmological redshifts [astro-ph-0405083].

- [10] Riess, A.G. et al. Type Ia Supernova Discoveries at $z > 1$ From the Hubble Space Telescope ... [astro-ph/0402512] (to appear in *ApJ*, 2004).
- [11] Ivanov, M.A. Contribution to The Tenth Marcel Grossmann Meeting (MG10), 20-26 July 2003, Rio de Janeiro, Brazil; [gr-qc/0307093].
- [12] Ivanov, M.A. Contribution to the Conference "Thinking, Observing and Mining the Universe" (Thinking2003), 22-27 Sep 2003, Sorrento, Italy; [astro-ph/0309566].
- [13] Freedman, W. L. et al. *ApJ* 2001, 553, 47.
- [14] Filippenko, A.V. [astro-ph/0410609]; to be published in *White Dwarfs: Probes of Galactic Structure and Cosmology*, Sion, E. M., Shipman, H. L., Vennes, S., Eds.; Kluwer: Dordrecht.
- [15] Willick, J.A., Puneet Batra. *ApJ* 2001, 548, 564.
- [16] Ivanov, M.A. In *Searches for a mechanism of gravity*, Ivanov, M.A., Savrov, L.A., Eds.; Nikolaev, Yu.A. Publisher: Nizhny Novgorod, 2004, pp 266-273 (in Russian).
- [17] Ivanov, M.A. A quantum gravitational model of redshifts [astro-ph/0409111].
- [18] Ivanov, M.A. Model of graviton-dusty universe [gr-qc/0107047] (see Chapter 2).
- [19] Milgrom, M. In the Proceedings of the II Int. Workshop on the Identification of Dark Matter, Buxton, England, 1998; World Scientific: Singapore, 1999; [astro-ph/9810302].
- [20] Shapiro, I.L., Sola, J., Stefancic, H. Running G and Λ at low energies from physics at M_X : possible cosmological and astrophysical implications [hep-ph/0410095].
- [21] Reuter, M., Weyer, H. Running Newton Constant, Improved Gravitational Actions, and Galaxy Rotation Curves [hep-th/0410117].

- [22] Ivanov, M.A. Contribution to The 14th Workshop on General Relativity and Gravitation (JGRG14), Nov 29 - Dec 3 2004, Kyoto, Japan; [gr-qc/0410076] (see Chapter 5).
- [23] Ivanov, M.A. Contribution to the Quantum Electronics and Laser Science Conference (QELS'95), May 21-26, 1995, Baltimore, USA; paper number: QThG1.
- [24] Adler, S.L. et al. *Phys. Rev.* 1976, *D14*, 359.
- [25] Adler, S.L. *Phys. Rev.* 1976, *D14*, 379.
- [26] Ivanov, M.A. Contribution to The sixth international symposium "Frontiers of Fundamental and Computational Physics" (FFP6), 26-29 September 2004, Udine, Italy; [astro-ph/0409631] (see Chapter 4).
- [27] Sakharov, A.D. *JETP* 1980, *79*, 689.
- [28] Penrose. R. In the Einstein Survey *General Relativity*, Hawking, S.W., Israel, W., Eds.; Cambridge University Press: 1979.

Chapter 8

Galaxy number counts in a presence of the graviton background

1

In the model of low-energy quantum gravity by the author, cosmological redshifts are caused by interactions of photons with gravitons. Non-forehead collisions with gravitons will lead to an additional relaxation of any photonic flux. Using only the luminosity distance and a geometrical one as functions of a redshift in this model, theoretical predictions for galaxy number counts are considered here. The Schechter luminosity function with $\alpha = -2.43$ is used. The considered model provides a good fit to galaxy observations by Yasuda et al. (AJ, 122 (2001) 1104) if the same K-corrections are added. It is shown that observations of $N(z)$ for different magnitudes m are a lot more informative than the ones of $N(m)$.

PACS: 98.80.-k Cosmology; 98.80.Es Observational cosmology; 04.60.-m Quantum gravity; 98.62.Py Distances, redshifts, radial velocities; spatial distribution of galaxies

¹[arXiv:astro-ph/0606223v3]

8.1 Introduction

The standard cosmological model explains observations only under the circumstance that almost all matter and energy of the Universe are hidden in some unknown *dark* forms. In my model of low-energy quantum gravity based on the idea of an existence of the background of super-strong interacting gravitons (for more details, see [1]), a cosmological redshift is caused by interactions of photons with gravitons. Non-forehead collisions with gravitons lead to a very specific additional relaxation of any photonic flux that gives a possibility of another interpretation of supernovae 1a data - without any kinematics or dark energy [1]. I would like to summarize here the main cosmologically essential consequences of this model. Average energy losses of a photon with an energy E on a way dr through the graviton background will be equal to: $dE = -aEdr$, where $a = H/c$, H is the Hubble constant. If we introduce a new dimensional constant D , so that: $\sigma(E, \epsilon) = D \cdot E \cdot \epsilon$, $\sigma(E, \epsilon)$ is a cross-section of interaction by forehead collisions of a photon with an energy E and a graviton with an energy ϵ , then we can compute the Hubble constant in this approach: $H = (1/2\pi)D \cdot \bar{\epsilon} \cdot (\sigma T^4)$, where $\bar{\epsilon}$ is an average graviton energy, and T is a temperature of the background. The constant D should have the value: $D = 0.795 \cdot 10^{-27} m^2/eV^2$; the one may be found from the Newtonian limit of gravity. If r is a geometrical distance from a source, then we have for $r(z)$, z is a redshift: $r(z) = \ln(1+z)/a$. None-forehead collisions of photons with gravitons of the background will lead to a scatter of photons and to an additional relaxation of a photonic flux, so that the luminosity distance D_L is equal in this approach to: $D_L = a^{-1} \ln(1+z) \cdot (1+z)^{(1+b)/2} \equiv a^{-1} f_1(z)$, where $f_1(z) \equiv \ln(1+z) \cdot (1+z)^{(1+b)/2}$ is the luminosity distance in units of c/H . This luminosity distance function fits supernova observations very well for roughly $z < 0.5$. It excludes a need of any dark energy to explain supernovae dimming.

In this paper, I consider galaxy number counts/redshift and counts/magnitude relations on a basis of this model. I assume here that a space is flat and the Universe is not expanding.

8.2 The galaxy number counts-redshift relation

Total galaxy number counts $dN(r)$ for a volume element $dV = d\Omega r^2 dr$ is equal to: $dN(r) = n_g dV = n_g d\Omega r^2 dr$, where n_g is a galaxy number density (it is constant in the no-evolution scenario), $d\Omega$ is a solid angle element. Using the function $r(z)$ of this model, we can re-write galaxy number counts as a function of a redshift z :

$$dN(z) = n_g d\Omega (H/c)^{-3} \frac{\ln^2(1+z)}{1+z} dz. \quad (8.1)$$

Let us introduce a function (see [2])

$$f_2(z) \equiv \frac{(H/c)^3 dN(z)}{n_g d\Omega z^2 dz};$$

then we have for it in this model:

$$f_2(z) = \frac{\ln^2(1+z)}{z^2(1+z)}. \quad (8.2)$$

A graph of this function is shown in Fig. 1; the typical error bar and data point are added here from paper by Loh and Spillar [3]. There is not a visible contradiction with observations. *There is not any free parameter in the model to fit this curve;* it is a very rigid case.

It is impossible to count a *total* galaxy number for big redshifts so as very faint galaxies are not observable. For objects with a fixed luminosity, it is easy to find how their magnitude m changes with a redshift. So as $dm(z)$ under a constant luminosity is equal to: $dm(z) = 5d(\lg D_L(z))$, we have for $\Delta m(z_1, z_2) \equiv \int_{z_1}^{z_2} dm(z)$:

$$\Delta m(z_1, z_2) = 5 \lg(f_1(z_2)/f_1(z_1)). \quad (8.3)$$

This function is shown in Fig.2 for $z_1 = 0.001; 0.01; 0.1$.

I would like to note that a very fast *initial* growth of the luminosity distance with a redshift z in this model might explain the observed excess of faint blue galaxy number counts above an expected one in the standard model (for example, see [4]). A galaxy color depends on a redshift, and a galaxy dimming depends on the luminosity distance, because by big values of the ratio $\Delta m(z_1, z_2)/(z_2 - z_1)$ in a region of small redshifts and by a further much slower change of it (see Fig.3) an observer will see many faint but blue enough galaxies in this region (in the no-evolution scenario).

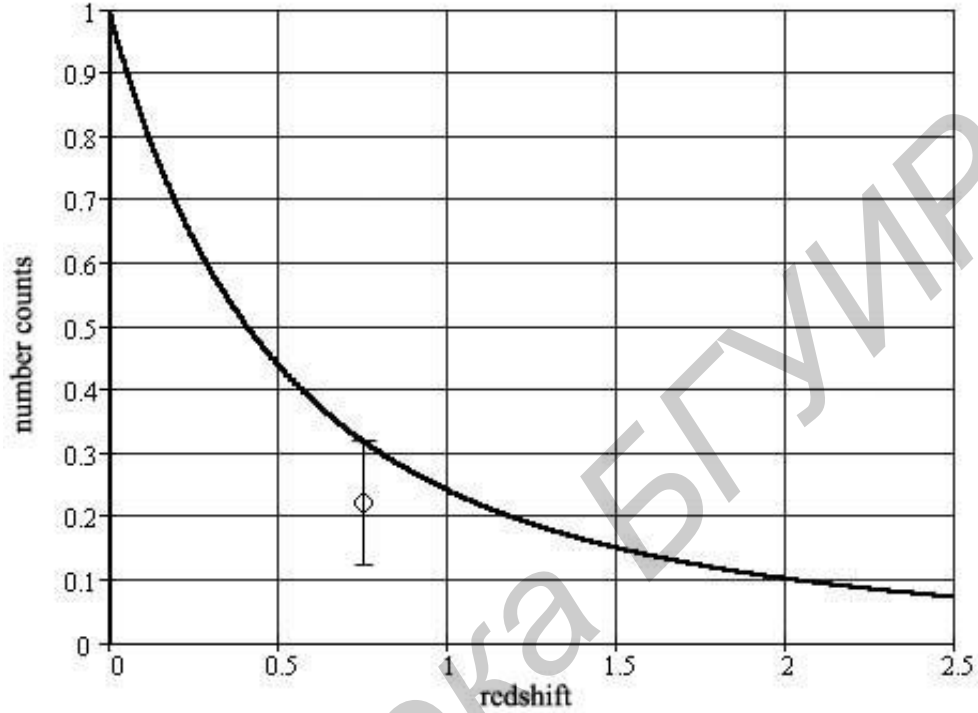

Figure 8.1: Number counts f_2 as a function of the redshift in this model. The typical error bar and data point are taken from paper by Loh and Spillar [3].

8.3 Taking into account the galaxy luminosity function

Galaxies have different luminosities L , and we can write n_g as an integral: $n_g = \int dn_g(L)$, where $dn_g(L) = \eta(L)dL$, $\eta(L)$ is the galaxy luminosity function. I shall use here the Schechter luminosity function [5]:

$$\eta(L)dL = \phi_* \left(\frac{L}{L_*}\right)^\alpha \exp\left(-\frac{L}{L_*}\right) d\left(\frac{L}{L_*}\right) \quad (8.4)$$

with the parameters ϕ_* , L_* , α .² So as we have by a definition of the luminosity distance $D_L(z)$ that a light flux I is equal to: $I = \frac{L}{4\pi D_L^2(z)}$, and a visible

²To turn aside the problem with divergencies of this function by small L for negative values of α , all computations are performed here for $z > 0.001$.

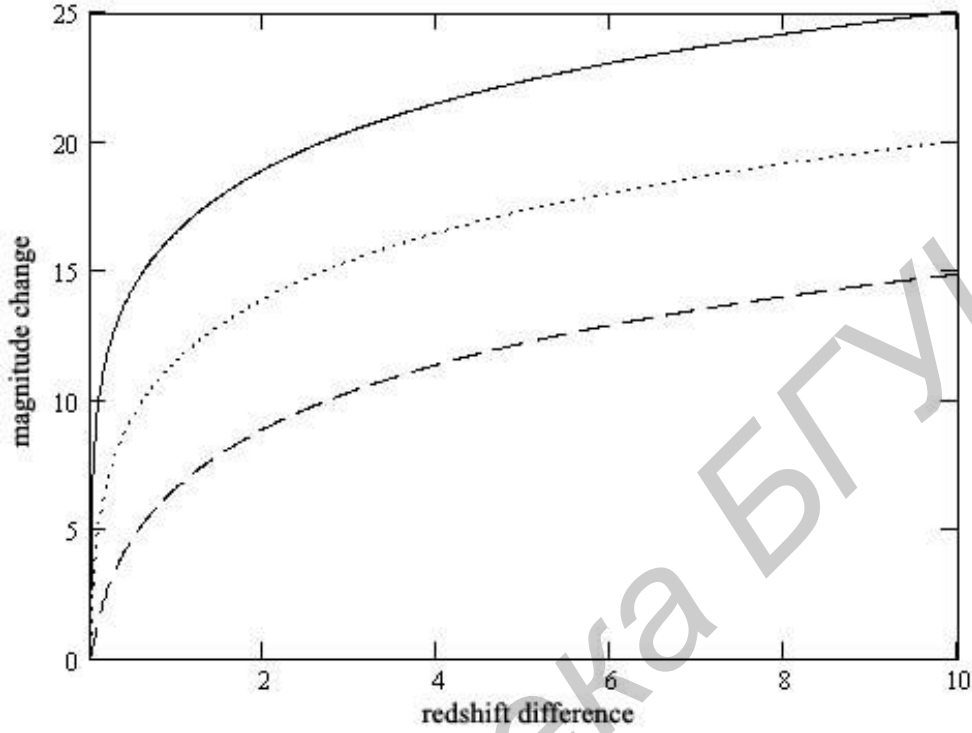

Figure 8.2: Magnitude changes Δm as a function of the redshift difference $z_2 - z_1$ in this model for $z_1 = 0.001$ (solid); 0.01 (dot); 0.1 (dash).

magnitude m of an object is $m = -2.5 \lg I + C$, where C is a constant, then m is equal to:

$$m = -2.5 \lg I + 5 \lg D_L(z) + (C - 4\pi). \quad (8.5)$$

We can write for L :

$$L = A \cdot \frac{D_L^2(z)}{\kappa^m}, \quad (8.6)$$

where $\kappa = 10^{0.4}$, $A = const$. For a thin layer with $z = const$ we have:

$$dL = \frac{\partial L}{\partial m} \cdot dm,$$

where

$$\frac{\partial L}{\partial m} = -m\kappa \cdot A \frac{D_L^2(z)}{\kappa^m} = -m\kappa L. \quad (8.7)$$

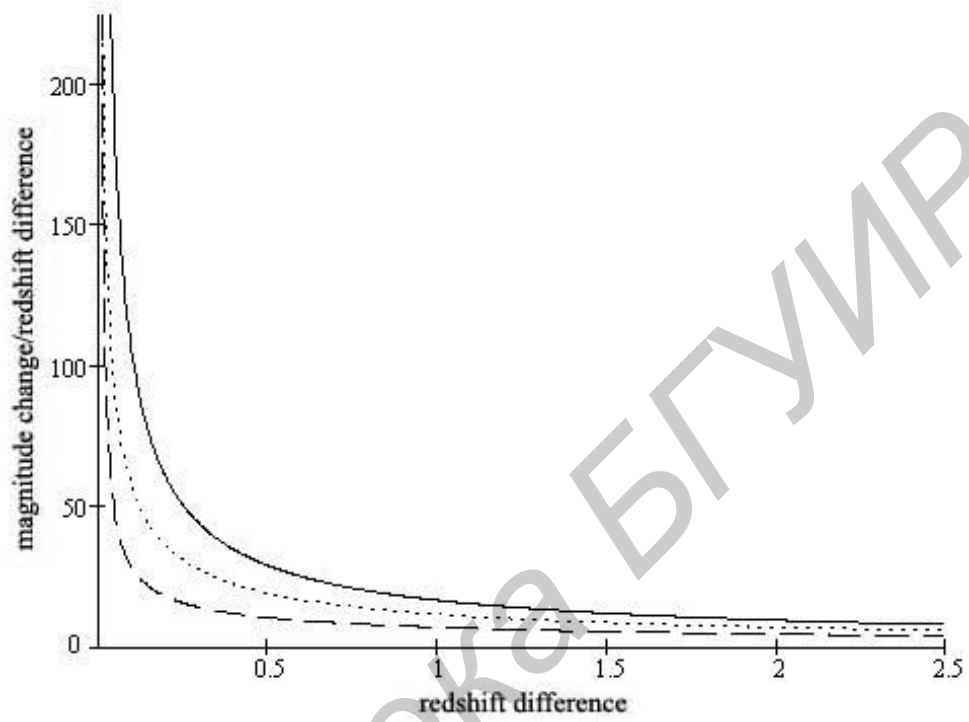

Figure 8.3: To a possible explanation of the excess of faint blue galaxy number counts: $\Delta m(z_1, z_2)/(z_2 - z_1)$ vs. the redshift difference $z_2 - z_1$ in this model for $z_1 = 0.001$ (solid); 0.01 (dot); 0.1 (dash).

Then

$$dn_g(m, z) = -(\phi_* \kappa) \cdot l^\alpha(m, z) \exp(-l(m, z)) \cdot (m \cdot l(m, z)) dm, \quad (8.8)$$

where $(-dm)$ corresponds to decreasing m by growing L when $z = \text{const}$, and

$$l(m, z) \equiv \frac{L(m, z)}{L_*}.$$

Let us introduce a function $f_3(m, z)$ with a differential

$$df_3(m, z) \equiv \frac{dN(m, z)}{d\Omega(-dm)}. \quad (8.9)$$

We have for this differential in the model:

$$df_3(m, z) = \left(\frac{\phi_* \kappa}{a^3}\right) \cdot m \cdot l^{\alpha+1}(m, z) \cdot \exp(-l(m, z)) \cdot \frac{\ln^2(1+z)}{(1+z)} dz, \quad (8.10)$$

where $a = H/c$, H is the Hubble constant. An integral on z gives the galaxy number counts/magnitude relation:

$$f_3(m) = \left(\frac{\phi_* \kappa}{a^3}\right) \cdot m \cdot \int_0^{z_{max}} l^{\alpha+1}(m, z) \cdot \exp(-l(m, z)) \cdot \frac{\ln^2(1+z)}{(1+z)} dz; \quad (8.11)$$

I use here an upper limit $z_{max} = 10$. To compare this function with observations by Yasuda et al. [6], let us choose the normalizing factor from the condition: $f_3(16) = a(16)$, where

$$a(m) \equiv A_\lambda \cdot 10^{0.6(m-16)} \quad (8.12)$$

is the function assuming "Euclidean" geometry and giving the best fit to observations [6], $A_\lambda = const$ depends on the spectral band. In this case, we have two free parameters - α and L_* - to fit observations, and the latter one is connected with a constant $A_1 \equiv \frac{A}{a^2 L_*}$ if

$$l(m, z) = A_1 \frac{f_1^2(z)}{\kappa^m}.$$

If we use the magnitude scale in which $m = 0$ for Vega then $C = 2.5 \lg I_{Vega}$, and we get for A_1 by $H = 2.14 \cdot 10^{-18} \text{ s}^{-1}$ (it is a theoretical estimate of H in this model [1]):

$$A_1 \simeq 5 \cdot 10^{17} \cdot \frac{L_\odot}{L_*}, \quad (8.13)$$

where L_\odot is the Sun luminosity; the following values are used: $L_{Vega} = 50L_\odot$, the distance to Vega $r_{Vega} = 26 \text{ LY}$.

Without the factor m , the function $f_3(m)$ by $\exp(-l(m, z)) \rightarrow 1$ would be close to $a(m)$ by $\alpha = -2.5$. Matching values of α shows that $f_3(m)$ is the closest to $a(m)$ in the range $10 < m < 20$ by $\alpha = -2.43$. The ratio $\frac{f_3(m)-a(m)}{a(m)}$ is shown in Fig.4 for different values of A_1 by this value of α . All such the curves conflow by $A_1 \leq 10^2$ (or $5 \cdot 10^{15} < L_*$), i.e. observations of the galaxy number counts/magnitude relation are *non-sensitive* to A_1 in this range. For fainter magnitudes $20 < m < 30$, the behavior of all curves is identical: they go below of the ratio value 1 with the same slope. If we compare this figure with Figs. 6,10,12 from [6], we see that the considered model provides a no-worse fit to observations than the function $a(m)$ if the same K-corrections are added (I think that even a better one if one takes into account positions

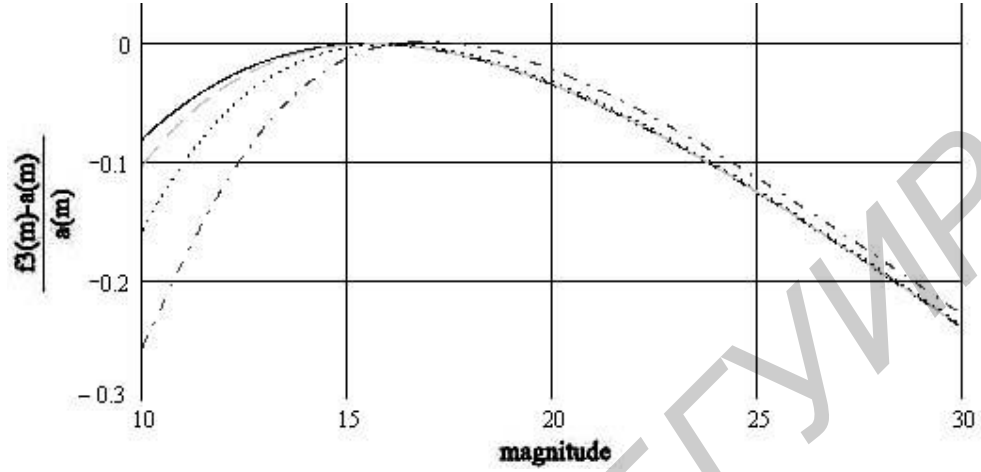

Figure 8.4: The relative difference $(f_3(m) - a(m))/a(m)$ as a function of the magnitude m for $\alpha = -2.43$ by $10^{-2} < A_1 < 10^2$ (solid), $A_1 = 10^4$ (dash), $A_1 = 10^5$ (dot), $A_1 = 10^6$ (dadot).

of observational points in Figs. 6,10,12 from [6] by $m < 16$ and $m > 16$) for the range $10^2 < A_1 < 10^7$ that corresponds to $5 \cdot 10^{15} > L_* > 5 \cdot 10^{10}$.

Observations of $N(z)$ for different magnitudes are a lot more informative. If we define a function $f_4(m, z)$ as

$$f_4(m, z) \equiv \left(\frac{a^3}{\phi_* \kappa} \right) \cdot \frac{df_3(m, z)}{dz}, \quad (8.14)$$

this function is equal in the model to:

$$f_4(m, z) = m \cdot l^{\alpha+1}(m, z) \cdot \exp(-l(m, z)) \cdot \frac{\ln^2(1+z)}{(1+z)}. \quad (8.15)$$

Galaxy number counts in the range $m_1 < m < m_2$ are proportional to the function:

$$\begin{aligned} f_5(m_1, m_2) &\equiv \int_{m_1}^{m_2} f_4(m, z) dm = \\ &= \int_{m_1}^{m_2} m \cdot l^{\alpha+1}(m, z) \cdot \exp(-l(m, z)) \cdot \frac{\ln^2(1+z)}{(1+z)} dm. \end{aligned} \quad (8.16)$$

Graphs of both $f_4(m, z)$ and $f_5(m_1, m_2)$ are shown in Fig. 5 by $\alpha = -2.43$, $A_1 = 10^5$; they are very similar between themselves. We see that

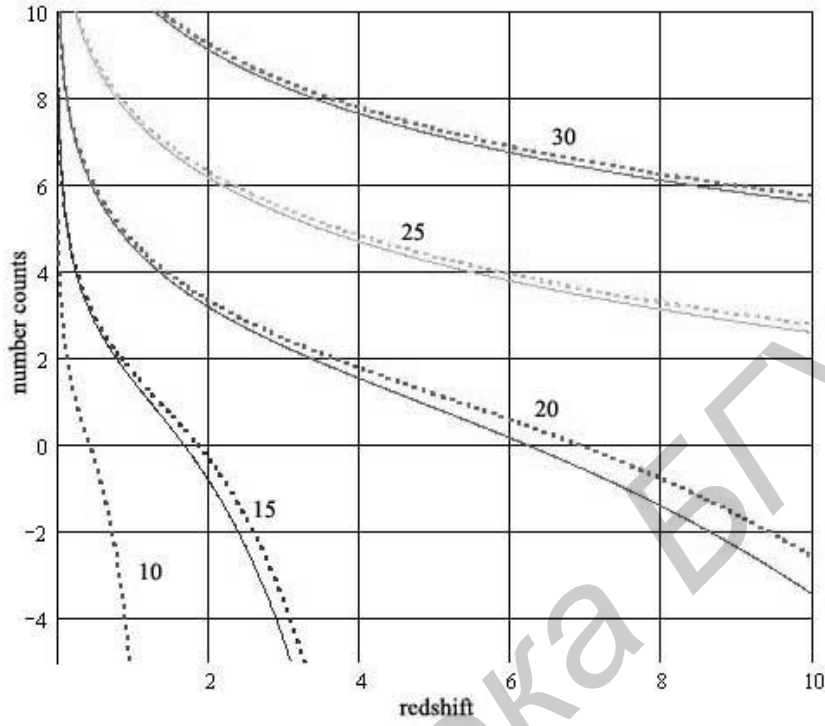

Figure 8.5: Number counts $f_4(m, z)$ (dot) and $f_5(m_1, m_2)$ (solid) (logarithmic scale) as a function of the redshift by $A_1 = 10^5$ for $\alpha = -2.43$, $m_1 = 10$ and different values of $m = m_2 : 15, 20, 25, 30$; $m = 10$ (only $f_4(m, z)$).

even the observational fact that a number of visible galaxies by $z \sim 10$ is very small allows us to restrict a value of the parameter A_1 much stronger than observations of $N(m)$.

8.4 Quasar number counts

For quasars, we can attempt to compute the galaxy number counts/redshift relation using Eq. 16 with another luminosity function $\eta'(l(m, z))$:

$$f_5(m_1, m_2) \equiv \int_{m_1}^{m_2} f_4'(m, z) dm = \int_{m_1}^{m_2} m \cdot l(m, z) \cdot \eta'(l(m, z)) \cdot \frac{\ln^2(1+z)}{(1+z)} dz. \quad (8.17)$$

The following luminosity functions were probed here (see Fig. 6): the Schechter one with $\alpha = 0$, $A_1 = 10^{6.55}$ (3', 3); the double power law [7],

[8]:

$$\eta'(l(m, z)) \propto \frac{1}{l^{-\alpha}(m, z) + l^{-\beta}(m, z)} \quad (8.18)$$

with $\alpha = -3.9$, $\beta = 1.6$, $A_1 = 4.5 \cdot 10^6$ (2', 2); the Gaussian one:

$$\eta'(l(m, z)) \propto \exp\left(\frac{-(l(m, z) - 1)^2}{2\sigma^2}\right) \quad (8.19)$$

with $\sigma = 0.5$, $A_1 = 4.5 \cdot 10^6$ (1', 1 dot); the combined one:

$$\eta'(l(m, z)) \propto l^\alpha(m, z) \cdot \exp\left(\frac{-(l(m, z) - 1)^2}{2\sigma^2}\right) \quad (8.20)$$

with two sets of parameters: $\alpha = -1.45$, $\sigma = 0.6$, $A_1 = 1.3 \cdot 10^6$ (4', 4 solid) and $\alpha = -1.4$, $\sigma = 0.7$, $A_1 = 3 \cdot 10^6$ (5', 5 dot). There are a couple of curves for each case: the left-shifted curve of any couple (1' - 5') corresponds to the range $16 < m < 18.25$, another one (1 - 5) corresponds to $18.25 < m < 20.85$. These ranges are chosen the same as in the paper by Croom et al. [7], and you may compare this figure with Fig. 3 in [7]. We can see that the theoretical distributions reflect only some features of the observed ones but not an entire picture. In all these cases, a slope of an analog of $\log(f_3(m))$ near $m = 18$ is in the range 0.29 - 0.325, when quasar observations give a larger slope (see Fig. 4, 21 in [7] and Fig. 13 in [8]; in the latter paper, this slope has been evaluated to be equal to about 1). We can summarize that, as well as in the standard cosmological model, it is impossible to fit quasar observations using some simple luminosity function with fixed parameters.

In the standard model, an easy way exists to turn aside this difficulty: one ascribes it to a quasar "evolution", then a luminosity function (for example, the double power law [7], [8]) is modified for different redshifts to take into account this "evolution". There exist two manner to do it: one may consider L_* as a function of a redshift (pure luminosity evolution) [7] or one may assume that indices α and β of the distribution (double power law) vary with z [8] - in both variants, it is possible to fit observations in some range of redshifts; of course, there are many other descriptions of the "evolution" [9]. It is strange only that "evolutions" are not concerted: we can see exponential, quadratic and other kinds of them - and it means that there is not any real evolution: we deal with a pure fine art of fitting, nothing more. In the considered model, this way is forbidden.

I think that it is necessary to consider some theoretical model of a quasar activity to get a distribution of "instantaneous" luminosities. It is known

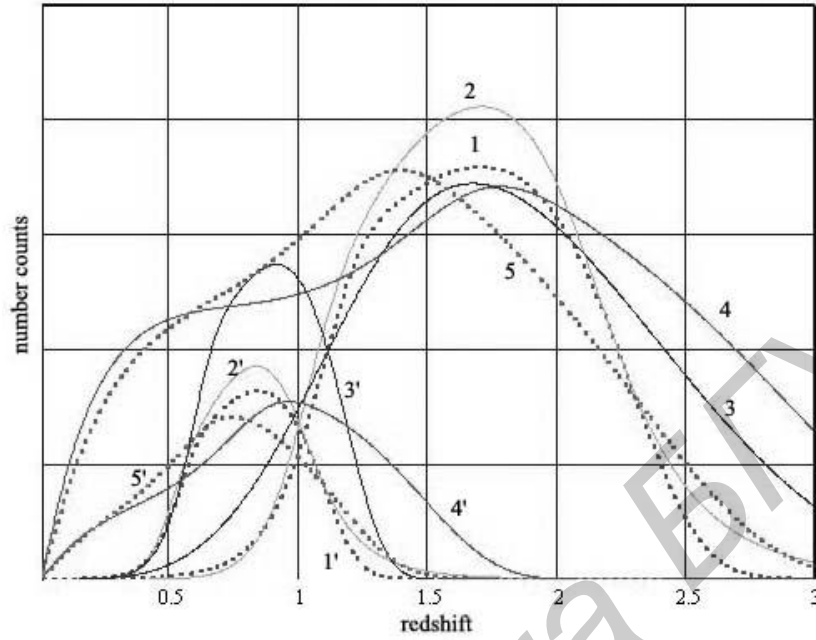

Figure 8.6: QSO number counts $f_5(m, z)$ (arbitrary units) as a function of the redshift for different luminosity functions: Gaussian (1', 1 dot), the double power law (2', 2), Schechter's (3', 3), combined (4', 4 solid and 5', 5 dot) with parameters given in the text. The left-shifted curve of each couple (1' - 5') corresponds to the range $16 < m < 18.25$, another one (1 - 5) corresponds to $18.25 < m < 20.85$.

that the typical lifetime of individual quasars is uncertain by several orders of magnitude; a lifetime of $4 \cdot 10^7$ years may be considered as an average value [10]. If one considers a quasar light curve $L(t)$ (in a manner which is similar to the one by Hopkins et al. [11]) in a parametric form, it is possible to get the luminosity function which takes into account a probability to observe a quasar with a given luminosity. Let us consider the two simple examples. The simplest case is a constant luminosity L of any quasar during its lifetime τ . If initial moments of quasar activity are distributed uniformly in time and may be described by a frequency ν , then a probability P_{obs} to observe a quasar will be equal to:

$$P_{obs} = \int_0^{\tau} \exp(-\nu t') d(\nu t') = 1 - \exp(-\nu \tau). \quad (8.21)$$

For $\nu\tau \ll 1$ we have $P_{obs} \simeq \nu\tau$. If we further assume that $\tau \propto 1/L$, i.e. that a full emitted quasar energy is constant, then a distribution of observable luminosities is

$$\eta'(L) \propto \eta(L) \cdot 1/L, \quad (8.22)$$

where $\eta(L)$ is an initial distribution of values of L .

The second example is the quasar exponential light curve:

$$L(t) = L_0 \exp(-t/\tau), \quad (8.23)$$

where τ is a lifetime, L_0 is an initial luminosity. If L_0 has a distribution $\eta(L_0)$, then we get:

$$\eta'(L) \propto \int \eta(L_0) \cdot [\exp(t_{max}/\tau(L_0)) - 1]^{-1} \cdot (L_0/L)^{2-\nu\tau(L_0)} \cdot dL_0, \quad (8.24)$$

where t_{max} is a maximum time during which one can distinguish a quasar from a host galaxy, and τ depends on L_0 in some manner. We see that even in this simple toy example the dependence on τ is not trivial.

In a general case, it is necessary to describe both - front and back - slopes of a quasar light curve. Together with a total emitted energy (or a peak luminosity), we need at least three independent parameters; if we take into account their random distributions, this number should be at least doubled.

8.5 Conclusion

Starting from a micro level and considering interactions of photons with single gravitons, we can find the luminosity distance and a geometrical distance in this approach. Using only these quantities, I compute here galaxy number counts-redshift and galaxy number counts-magnitude relations for a case of a flat non-expanding universe. It has been shown here that they are in a good accordance with observations. It may be important as for cosmology as for a theory of gravity.

Bibliography

- [1] Ivanov, M.A. 2006, Gravitons as super-strong interacting particles, and low-energy quantum gravity. In the book "Focus on Quantum Gravity Research", Ed. David C. Moore, Nova Science, New York, 2006, pp. 89-120; [hep-th/0506189 v3]; [<http://ivanovma.narod.ru/nova04.pdf>].
- [2] Cunha, J. V., Lima, J. A. S., N. Pires, A&A, 2002, 390, 809.
- [3] Loh, E.D. and Spillar, E.J. ApJ, 1986, 307, L1.
- [4] Driver, S.P., et al. ApJ, 1998, 496, L93.
- [5] Schechter, P.L. ApJ, 1976, 203, 297.
- [6] Yasuda, N. et al. AJ, 2001, 122,1104.
- [7] Croom, S.M. et al. MNRAS, 2004, 349, 1397.
- [8] Hopkins, P.F. et al. [astro-ph/0605678].
- [9] Richards, G.T. et al. [astro-ph/0601434].
- [10] Martini, P. and Weinberg, D.H. ApJ, 2001, 547, 12 [astro-ph/0002384].
- [11] Hopkins, P.F. et al. ApJ, 2006, 632, 700 [astro-ph/0508299].

Chapter 9

Hubble diagrams of soft and hard radiation sources in the graviton background: to an apparent contradiction between supernova 1a and gamma-ray burst observations

1

In the sea of super-strong interacting gravitons, non-forehead collisions with gravitons deflect photons, and this deflection may differ for soft and hard radiations. As a result, the Hubble diagram would not be a universal function and it will have a different view for such sources as supernovae in visible light and gamma-ray bursts. Observations of these two kinds are compared here with the limit cases of the Hubble diagram.

Keywords: galaxies: distances and redshifts - cosmology: observations - cosmology: theory - cosmology: distance scale – gamma-ray bursts: general

¹[arXiv:astro-ph/0609518v4]

9.1 Introduction

After the remarkable observations of supernovae 1a dimming [1, 2], the standard cosmological model has been changed, and such the new terms as dark energy and an acceleration of the expansion are now commonly known. Now another cosmological tool - gamma-ray bursts observations - makes its debut, but there exists some contradiction with supernova observations [3]: the Hubble diagrams for these two kinds of sources are not identical. In the model by the author [4] based on the conjecture about an existence of the sea of super-strong interacting gravitons, supernova observational data may be explained without dark energy. I would like to show here that this apparent contradiction between two kinds of observations may be resolved in my model in a very simple manner: soft and hard radiation sources may have different Hubble diagrams in it, and for an arbitrary set of sources, the Hubble diagram is a multivalued function of a redshift.

9.2 Limit cases of the Hubble diagram in the graviton background

In the standard cosmological model, the luminosity distance depends on 1) a redshift which conditions a loss of photon energies and 2) a history of expansion which defines how big is a surface on which photons fall. In the model by the author [4] (there is not any expansion in it), the first factor is the same, but there are the two new factors: 2') the geometrical distance r is a non-linear function of a redshift z and 3') non-forehead collisions with gravitons leads to an additional relaxation of any photonic flux. Namely, the luminosity distance is

$$D_L = a^{-1} \ln(1 + z) \cdot (1 + z)^{(1+b)/2},$$

where $a = H/c$, H is the Hubble constant and c is the light velocity. The theoretical value of relaxation factor b has been found in the assumption that in any case of a non-forehead collision of a graviton with a photon, the latter leaves a photon flux detected by a remote observer (the assumption of a narrow beam of rays - but it is not a well-chosen name): $b = 2.137$. It is obvious that this assumption should be valid for a soft radiation when a photon deflection angle is big enough and collisions are rare.

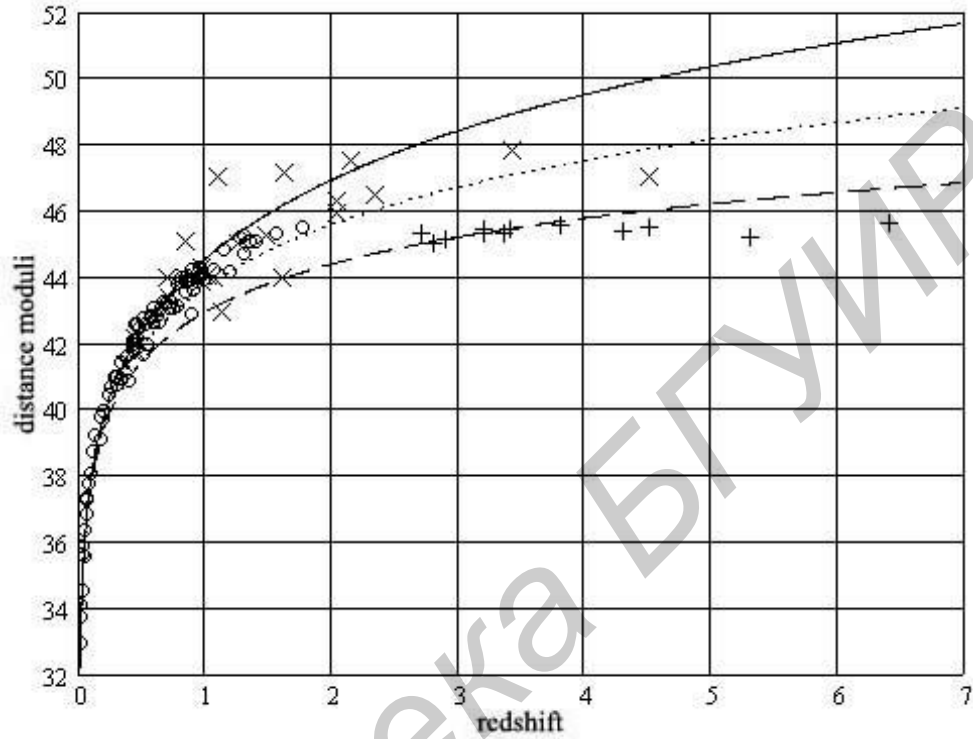

Figure 9.1: Hubble diagrams $\mu_0(z)$ with $b = 2.137$ (solid), $b = 1$ (dot) and $b = 0$ (dash); supernova observational data (circles, 82 points) are taken from Table 5 of [5], gamma-ray burst observations are taken from [6] (x, 24 points) and from [7] (+, 12 points for $z > 2.6$).

It is easy to find a value of the factor b in another marginal case - for a very hard radiation. Due to very small ratios of graviton to photon momenta, photon deflection angles will be small, but collisions will be frequent because the cross-section of interaction is a bilinear function of graviton and photon energies in this model. It means that in this limit case $b \rightarrow 0$.

For an arbitrary source spectrum, a value of the factor b should be still computed, and it will not be a simple task. It is clear that $0 \leq b \leq 2.137$, and in a general case it should depend on a rest-frame spectrum and on a redshift. It is important that the Hubble diagram is a multivalued function of a redshift: for a given z , b may have different values.

Theoretical distance moduli $\mu_0(z) = 5 \log D_L + 25$ are shown in Fig. 1

for $b = 2.137$ (solid), $b = 1$ (dot) and $b = 0$ (dash). If this model is true, all observations should lie in the stripe between lower and upper curves. For Fig. 1, supernova observational data (circles, 82 points) are taken from Table 5 of [5], gamma-ray burst observations are taken from [6] (x, 24 points) and from [7] (+, 12 points for $z > 2.6$). As it was recently shown by Cuesta et al. [3], the Hubble diagram with $b = 1$ (in the language of this paper) gives the best fit to the full sets of gamma-ray burst observations of [6, 7] and it takes place in the standard FLRW cosmology plus the strong energy condition. Twelve observational points of [7] belong to the range $z > 2.6$, and one can see (Fig. 1) that these points peak up the curve with $b = 0$ which corresponds in this model to the case of very hard radiation in the non-expanding Universe with a flat space. In a frame of models without expansion, any red-shifted source may not be brighter than it is described with this curve.

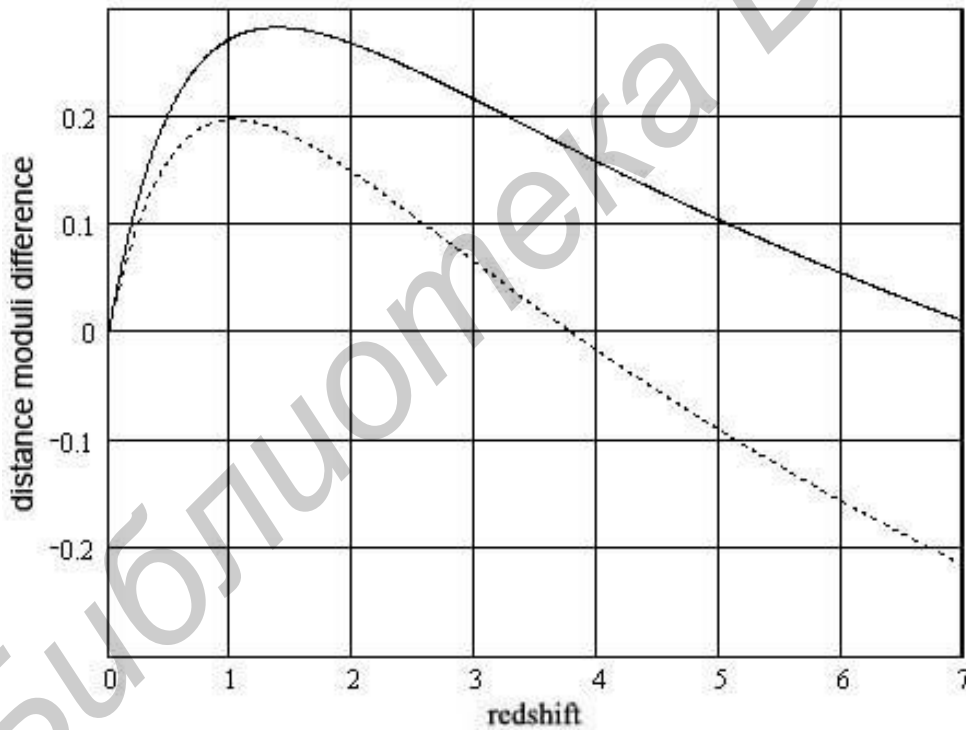

Figure 9.2: The difference $\mu_c(z) - \mu_0(z)$ for $b = 1$ (solid) and $b = 1.1$ (dot).

Very recently, Schaefer [8] has published a collection of 69 gamma-ray burst observations where calculated distance moduli are *model-dependent*:

some cosmological model is used *to calculate the luminosity distance* which is used to evaluate parameters of bursts. When one compares - after it - GRB observations with the used cosmological model constructing the Hubble diagram, one is restricted to be able to check only the self-consistency of the initial conjecture that the chosen model is true. As it is shown in Fig. 2, theoretical distance moduli $\mu_c(z)$ for a flat Universe with the concordance cosmology with $\Omega_M = 0.27$ and $w = -1$, which give the best fit to obser-

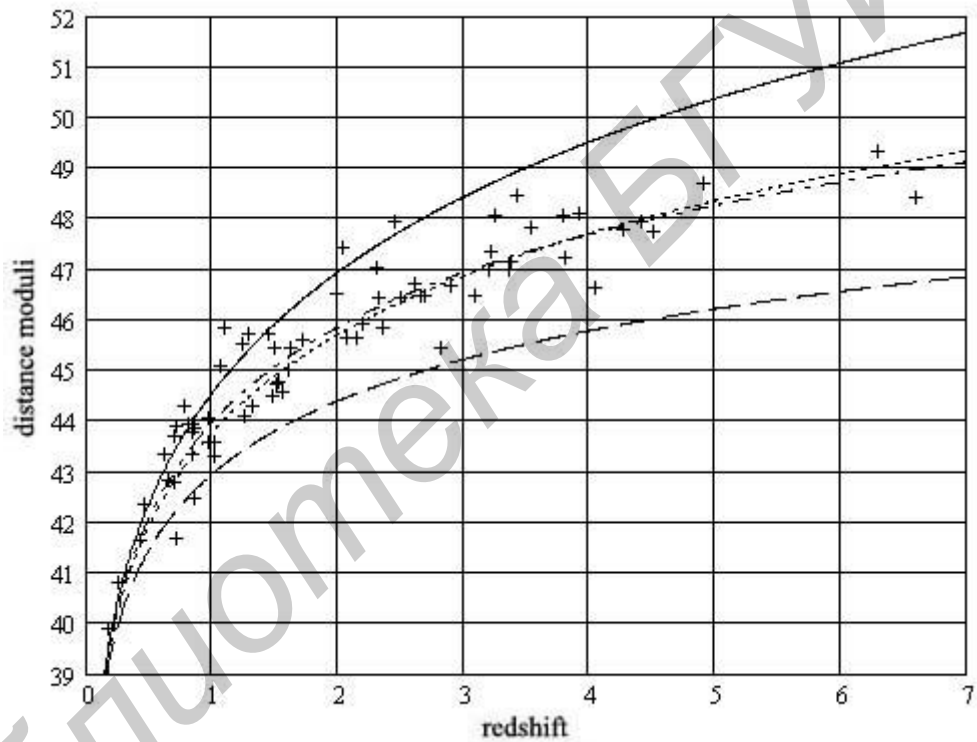

Figure 9.3: The same as in Fig. 1 Hubble diagrams $\mu_0(z)$ with $b = 2.137$ (solid) and $b = 0$ (dash); the Hubble diagrams $\mu_0(z)$ with $b = 1.1$ of this model (dot) and the one of the concordance model (dadot) which is the best fit to observations [8]; GRB observational data (+, 69 points) are taken from Table 6 (μ^a) of [8] by Schaefer.

vations [8], are very close to the Hubble diagram $\mu_0(z)$ with $b = 1.1$ of this model (the difference is not bigger than ± 0.2 mag in the range $z \leq 6.6$). Because of this, I would like to compare his calculated GRB distance moduli

for a flat Universe with the concordance cosmology (see Table 6 of [8]) with theoretical predictions of the considered model in Fig. 3. We can see that GRB observations lie in the stripe between lower and upper curves of this

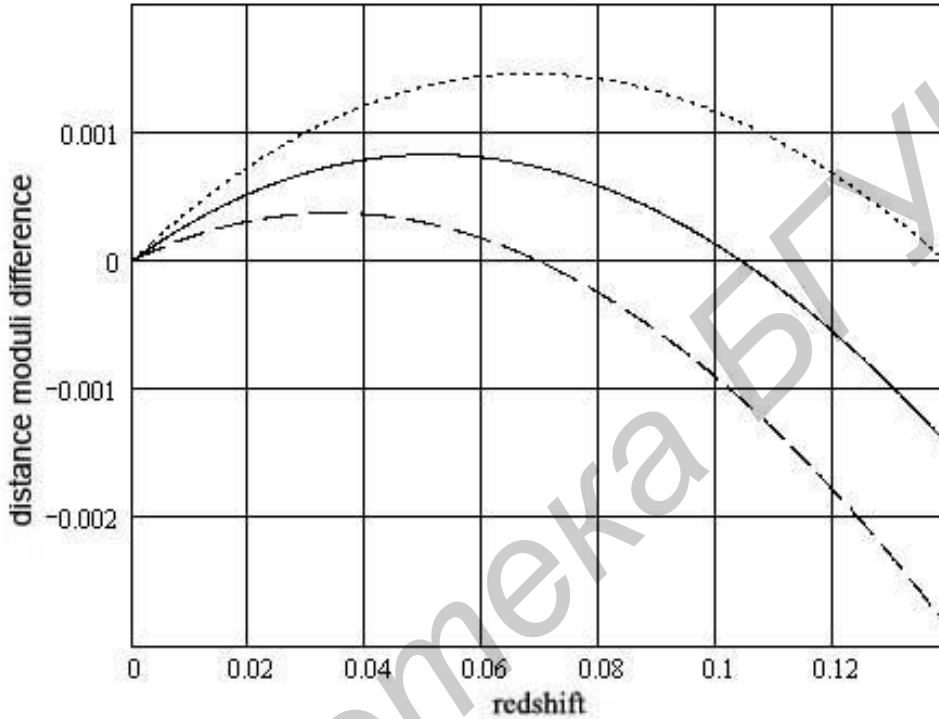

Figure 9.4: The difference $\mu_c(z) - \mu_0(z)$ for $b = 1.52$ (solid), $b = 1.51$ (dot) and $b = 1.53$ (dash); $\mu_c(z)$ corresponds to a flat Universe with the concordance cosmology with $\Omega_M = 0.30$ and $w = -1$, which gives the best fit to supernova observations for small redshifts [9].

model, and the curve $\mu_0(z)$ with $b = 1.1$ (or with some bigger b) may replace $\mu_c(z)$ with a success. But this curve *is not* the limit case for a very hard radiation. Comparing GRB observational points on Fig. 1 and Fig. 3 for the same range of $z > 2.6$, we see also that distance moduli of the last set are essentially higher than the ones reported in [7] by the same author.

Improved distances to nearby type Ia supernovae (for the range $z < 0.14$) can be fitted with the function $\mu_c(z)$ for a flat Universe with the concordance cosmology with $\Omega_M = 0.30$ and $w = -1$ [9]. In Fig. 4, the difference $\mu_c(z) - \mu_0(z)$ between this function and distance moduli in the considered

model is shown for $b = 1.52$ (solid), $b = 1.51$ (dot) and $b = 1.53$ (dash). For $b = 1.52$, this difference has the order of ± 0.001 in the considered range of redshifts.

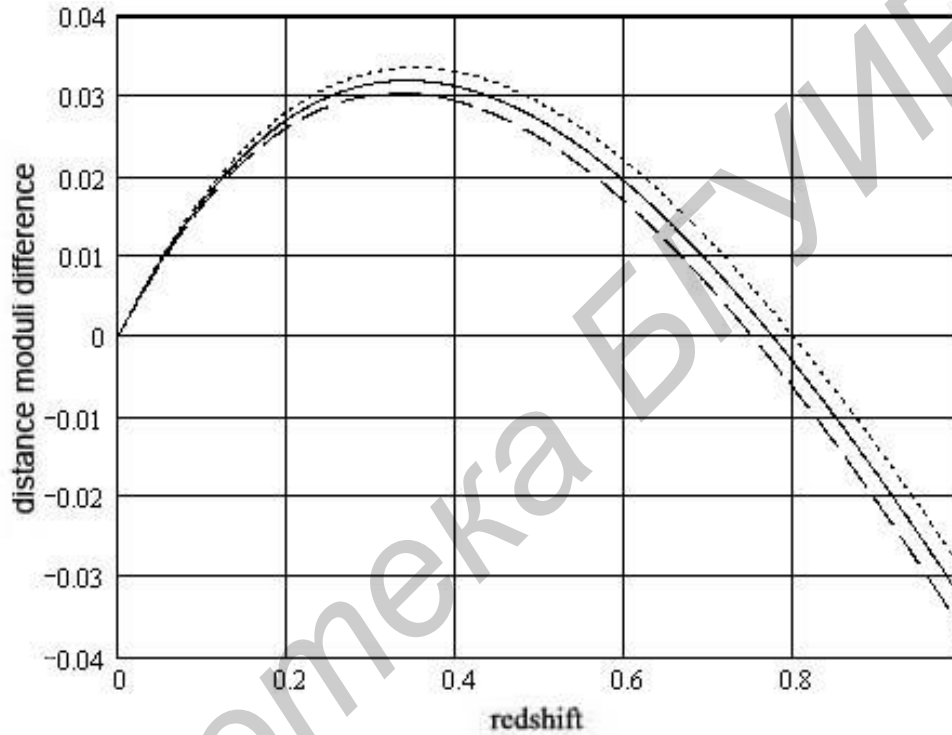

Figure 9.5: The difference $\mu_c(z) - \mu_0(z)$ for $b = 1.405$ (solid), $b = 1.400$ (dot) and $b = 1.410$ (dash); $\mu_c(z)$ corresponds to a flat Universe with the concordance cosmology with $\Omega_M = 0.27$ and $w = -1$, which gives the best fit to supernova observations for the bigger redshift range $z < 1$ [10].

Results from the ESSENCE Supernova Survey together with other known supernovae 1a observations in the bigger redshift range $z < 1$ can be best fitted in a frame of the concordance cosmology in which $\Omega_M \simeq 0.27$ and $w = -1$ [10]; the function $\mu_c(z)$ for this case is almost indistinguishable from distance moduli in the considered model for $b = 1.405$. In Fig. 5, the difference $\mu_c(z) - \mu_0(z)$ is shown for $b = 1.405$ (solid), $b = 1.400$ (dot) and $b = 1.410$ (dash). For $b = 1.405$, this difference is not bigger than ± 0.035 for redshifts $z < 1$ (the same is true for slightly different values of Ω_M used in

[10], too, but for some other values of the factor b : for $\Omega_M = 0.274$ or 0.267 , b is equal to 1.400 or 1.410 correspondingly).

The gold sample of supernovae [5] by Riess et al. has the best fit with $w(z) = w_0 + w'z$, where $w_0 = -1.31$ and $w' = 1.48$ (dark energy changes with redshift); because this supernovae Hubble diagram goes below of the GRB one [8] for $z > 1$, and in a frame of the considered model it is *impossible*, it may be that the GRB derived distance moduli by Schaefer [8] are not consistent now with the supernovae observations.

9.3 Conclusion

The considered multivalued character of the Hubble diagram may explain an apparent contradiction between supernovae and GRBs observations. We have now a very poor set of GRBs with big redshifts, and it is obvious that errors of observations are very large. When such missions as the SWIFT satellite observe much more GRBs at high redshifts, one can get a surprising result: observations would lie on the curve which corresponds to the non-expanding Universe. It would be very important to get supernova data for higher redshifts with the help of new missions to be able to do more definitive conclusions.

Bibliography

- [1] Riess, A.G. et al. *AJ*, 1998, *116*, 1009.
- [2] Perlmutter, S. et al. *ApJ*, 1999, *517*, 565.
- [3] Cuesta, H.J.M. et al. [astro-ph/0609262].
- [4] Ivanov, M.A. In the book *Focus on Quantum Gravity Research*, Ed. David C. Moore, Nova Science, New York, 2006, pp. 89-120; [hep-th/0506189 v3]; [<http://ivanovma.narod.ru/nova04.pdf>].
- [5] Riess, A.G. et al. *ApJ*, 2004, *607*, 665; [astro-ph/0402512].
- [6] Bloom, J.S., Frail, D.A., and Kulkarni, S.R. *ApJ*, 2003, *594*, 674.
- [7] Schaefer, B.E. *BAAS*, 2005, *37*, 1418; 207 AAS Meeting, 2006.
- [8] Schaefer, B.E. [astro-ph/0612285].
- [9] Jha, Saurabh, Riess, A.G. and Kirshner, R.P. [astro-ph/0612666].
- [10] Wood-Vasey, W. M. et al. [astro-ph/0701041].

Chapter 10

A few remarks about the Pioneer anomaly

¹

Some features of the Pioneer anomaly are discussed in context of author's explanation of this effect as a deceleration of the probes in the graviton background. It is noted that if the model is true then the best parameter of the anomalous acceleration should be not the distance to the Sun but a cosine of the angle between a velocity of the probe and its radius-vector.

As it was reported by the authors of the discovery, NASA deep-space probes Pioneer 10/11 experience an anomalous constant acceleration directed towards the Sun (the Pioneer anomaly) [1, 2]. A possible origin of the effect remains unknown. In my model [3], any massive body must experience a constant deceleration $w \simeq -Hc$, where H is the Hubble constant and c is the light velocity, of the same order of magnitude as observed for cosmic probes. This effect is an analogue of cosmological redshifts in the model. Their common nature is forehead collisions with gravitons. I would like to consider here the main known features of this anomaly in context of my explanation keeping in mind present and future efforts to verify the reality of this effect and to understand it.

The observed anomaly has the following main features: 1) in the range 5 - 15 AU from the Sun it is observed an anomalous sunward acceleration with the rising modulus which gets its maximum value, leastwise for Pioneer 11

¹[arXiv:0711.0450v2 [physics.gen-ph]]

(see Fig. 3 in [2]); 2) for greater distances, this maximum sunward acceleration remains almost constant for both Pioneers [1, 2]; 3) also it is observed an unmodeled annual periodic term in residuals for Pioneer 10 [4] which is obviously connected with the motion of the Earth.

If my conjecture [3] about the quantum nature of this acceleration is true then an observed value of the projection of the probe's acceleration on the sunward direction w_s should depend on accelerations of the probe, the Earth and the Sun relative to the graviton background. If we assume that the Sun moves relative to the background slowly enough, then anomalous accelerations of the Earth and the probe will be directed almost against their velocities in the heliocentric frame, and in this case: $w_s = -w \cdot \cos\alpha$, where α is an angle between a radius-vector of the probe and its velocity in the frame. For a terrestrial observer, an additional term should be taken into account which is connected with its own motion relative to the background.

By the very elongate orbits of the both Pioneers (see Fig. 3 in [2]), it would explain the second (and main) peculiarity. For example, for Pioneer 10 at the distance 67 AU from the Sun one has $\sin\alpha \approx 0.11$ (it is a visual estimate with Fig. 3 of [?]), i.e. $\cos\alpha \approx 0.994$. If for big distances from the Sun we use the conservation laws of energy and angular momentum in the field of the Sun only, then in the range 6.7 - 67 AU a value of $\cos\alpha$ changes from 0.942 to 0.994, i.e. approximately on 5 per cent only. Due to this fact, a projection of the probe's acceleration on the sunward direction would be almost constant.

As Toth and Turyshev report [5], they intend to carry out an analysis of newly recovered data received from Pioneers, with these data are now available for Pioneer 11 for distances 1.01 - 41.7 AU. If the serious problem of taking into account the solar radiation pressure at small distances is precisely solved (modeled) [6], then this range will be very lucky to confront the expression $w_s = -w \cdot \cos\alpha$ of the considered model with observations for small distances when Pioneer 11 executed its planetary encounters with Jupiter and Saturn. In this period, a value of $\cos\alpha$ was changed in the non-trivial manner, and the projection of anomalous acceleration should behave itself similar. For example, when the spacecraft went to Saturn, $\cos\alpha$ was *negative* during some time. If this model is true, the anomaly in this small period should have *the opposite sign*. I think, it would be the best of all to compare the two functions of the probe's proper time: the projection of anomalous acceleration of Pioneer 11 and $\cos\alpha$ for it. These functions should be very similar to each other if my conjecture is true. At present, a new mission to

test the anomaly is planned [7]. It is seen from this consideration that it would be desirable to have a closed orbit for this future probe (or the one with two elongate branches where the probe moves off the Sun and towards it).

Leaving for the future the question about the stability and form of the Earth orbit by such the anomalous acceleration, I note that namely this one would cause feature 3) of the anomaly. In this case, because Pioneers 10 and 11 have different trajectories, it is possible to compute a sign of the projection of Earth's anomalous acceleration contribution: when the Earth moves after a probe, we should observe a minimum of the periodic term, and we should see a maximum when they move in opposite directions. For the twins, these maximums-minimums will appear in different time intervals, that is important to test the model.

The observed very tiny anomaly in the probe motion may be the first egress beyond the applicability limits of general relativity in the solar system. If my explanation of the one is true then this effect may turn out to be and the first observable macroscopic manifestation of low-energy quantum gravity.

Bibliography

- [1] Anderson, J.D. et al. *Phys. Rev. Lett.* 1998, *81*, 2858.
- [2] Anderson, J.D. et al. *Phys. Rev.* 2002, *D65*, 082004; [gr-qc/0104064 v4].
- [3] Ivanov, M.A. *General Relativity and Gravitation* 2001, *33*, 479; Erratum: 2003, *35*, 939; [astro-ph/0005084 v2] (see Chapter 1).
- [4] Turyshev, S.G. et al. XXXIV-th Rencontres de Moriond Meeting on Gravitational Waves and Experimental Gravity. Les Arcs, Savoie, France (January 23-30, 1999); [gr-qc/9903024 v2].
- [5] Toth, V.T. and Turyshev, S.G. "III Mexican Meeting on Mathematical and Experimental Physics," Mexico City, Mexico, 10-14 Sept. 2007, arXiv:0710.2656v1 [gr-qc].
- [6] Anderson, J.D. and Nieto, M.M. *Contemp. Phys.* 2007, *48*, No. 1. 41-54; arXiv:0709.3866v1 [gr-qc].
- [7] Dittus, H. et al. In: Trends in Space Science and Cosmic Vision 2020, Proceedings of the 39th ESLAB Symposium, eds. F. Favata and A. Gimenez, ESA Special Pub. 588, 3-10 (2005); [gr-qc/0506139].

Chapter 11

A non-universal transition to asymptotic freedom in low-energy quantum gravity

¹

The model of low-energy quantum gravity by the author has the property of asymptotic freedom at very short distances. The character of transition to asymptotic freedom is studied here. It is shown that this transition is not universal, but the one obeys the scaling rule: the range of this transition in units of $r/E^{1/2}$, where r is a distance between particles and E is an energy of the screening particle, is the same for any micro-particle. This range for a proton is between $10^{-11} - 10^{-13}$ meter, while for an electron it is approximately between $10^{-13} - 10^{-15}$ meter.

11.1 Introduction

Recently, it was shown by the author [1] that asymptotic freedom appears at very short distances in the model of low-energy quantum gravity [2]. In this case, the screened portion of gravitons tends to the fixed value of $1/2$, that leads to the very small limit acceleration of the order of $10^{-13} m/s^2$ of any screened micro-particle. While asymptotic freedom of strong interactions [3, 4] is due to the anti-screening effect of gluons, the gravitational one

¹Journal of Gravitational Physics, 2008, vol.2, No.2, pp. 26-31. [arXiv:0801.1973v1 [hep-th]]

is caused by the external character of graviton flux and the limited rise of the screened portion at ultra short distances. In this paper, I consider how a transition occurs from the inverse square law to almost full asymptotic freedom. The most important property of this transition is its non-universality: for different particles it takes place in different distance ranges, and the order of these ranges is terribly far from the Planck scale where one usually waits of manifestations of quantum gravity effects.

11.2 The screened portion of gravitons at very short distances

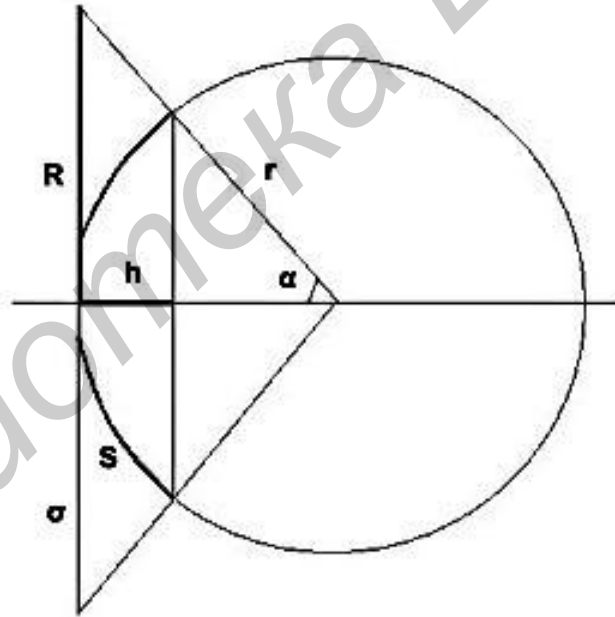

Figure 11.1: To the computation of the screened portion of gravitons at small distances: σ is the cross-section, S is a square of the spherical segment of a height h .

In the model of low-energy quantum gravity [2], the condition of big

distances:

$$\sigma(E_2, \langle \epsilon_2 \rangle) \ll 4\pi r^2. \quad (11.1)$$

should be accepted to have the Newton law of gravitation. I use here the notations of [2]: $\sigma(E_2, \langle \epsilon_2 \rangle)$ is the cross-section of interaction of graviton pairs with an average pair energy $\langle \epsilon_2 \rangle$ with a particle having an energy

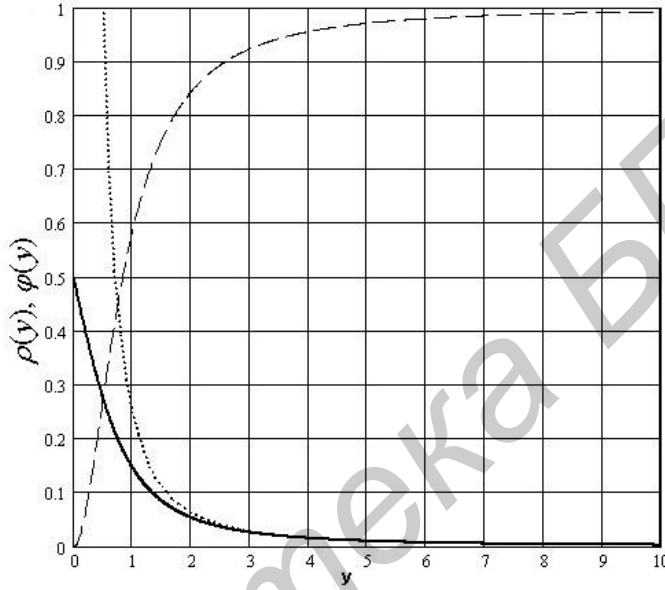

Figure 11.2: Graphs of the functions $\rho(y)$ (solid), $\rho(y)_d$ (dot), $\varphi(y)$ (dash) .

E_2 , r is a distance between particles 1 and 2. As it was shown in [5], the equivalence principle should be broken at distances $\sim 10^{-11}$ m, when the condition (1) is violated for a proton-mass particle. The ratio

$$\sigma(E_2, \langle \epsilon_2 \rangle)/4\pi r^2. \quad (11.2)$$

describes the screened portion of gravitons for a big distance r . For small r , let us consider Fig. 1, where $R = (\sigma(E_2, \langle \epsilon_2 \rangle)/\pi)^{1/2}$, S is the screening area (the square of the spherical segment of the height h), and α is an angle for which $\cot \alpha = r/R \equiv y$. Then we get for S :

$$S = 2\pi r^2(1 - y/(1 + y^2)^{1/2}), \quad (11.3)$$

and it is necessary to replace the ratio (2) by the following one:

$$\rho(y) \equiv S/4\pi r^2 = (1 - y/(1 + y^2)^{1/2})/2. \quad (11.4)$$

I rewrite (2) as $\rho(y)_{cl} \equiv 1/4y^2$, and I introduce the ratio of these functions:

$$\varphi(y) \equiv \rho(y)/\rho(y)_{cl} = 2y^2(1 - y/(1 + y^2)^{1/2}). \quad (11.5)$$

In Fig. 2, the behavior of the functions $\rho(y)$, $\rho(y)_{cl}$, $\varphi(y)$ is shown. The upper limit of $\rho(y)$ by $y \rightarrow 0$ is equal to $1/2$; namely this property of the function leads to asymptotic freedom [1].

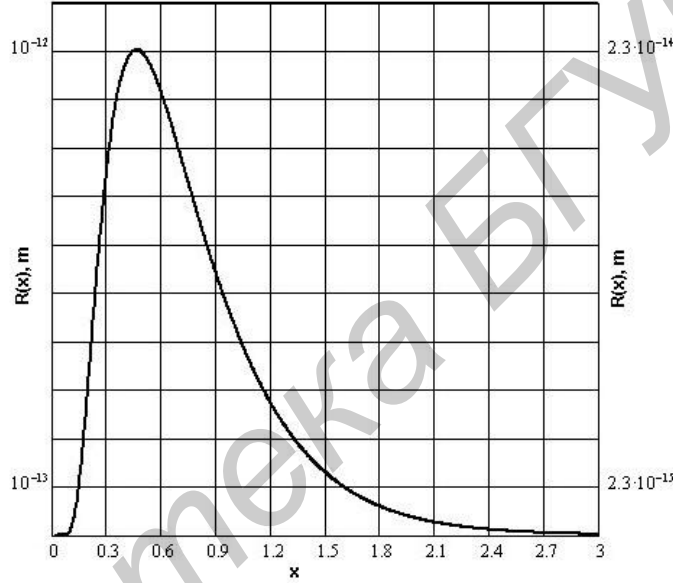

Figure 11.3: The function $R(x)$ for the two cases: $E_2 = m_p c^2$ (the left logarithmic vertical scale) and $E_2 = m_e c^2$ (the right logarithmic vertical scale).

In this model, the cross-section $\sigma(E_2, < \epsilon_2 >)$ is equal to [2]:

$$\sigma(E_2, < \epsilon_2 >) = \frac{DkTE_2 2x(1 - \exp(-(\exp(2x) - 1)^{-1}))(\exp(2x) - 1)^{-2}}{\exp((\exp(2x) - 1)^{-1}) \exp((\exp(x) - 1)^{-1})}, \quad (11.6)$$

where $T = 2.7K$ is the temperature of the graviton background, $x \equiv \hbar\omega/kT$, $\hbar\omega$ is a graviton energy, the new constant D has the value: $D = 0.795 \cdot 10^{-27} m^2/eV^2$. The quantity $R(x)$ has been computed for the two cases (see Fig. 3): $E_2 = m_p c^2$ (the left vertical axis on Fig. 3) and $E_2 = m_e c^2$ (the right vertical axis on Fig. 3), where m_p and m_e are masses of a proton and of an electron, correspondingly.

11.3 A non-universal transition to asymptotic freedom

To find the net force of gravitation $F = F_2/2$ at a small distance r , we should replace the factor $\sigma(E_2, < \epsilon_2 >)/4\pi r^2$ in Eq. (31) of [2] with the more exact factor $S/4\pi r^2$. Then we get:

$$F(r) = \frac{4}{3} \cdot \frac{D(kT)^5 E_1}{\pi^2 \hbar^3 c^3} \cdot g(r), \quad (11.7)$$

where E_1 is an energy of particle 1, and $g(r)$ is the function of r :

$$g(r) \equiv \int_0^\infty \frac{x^4 (1 - \exp(-(\exp(2x) - 1)^{-1})) (\exp(2x) - 1)^{-3}}{\exp((\exp(2x) - 1)^{-1}) \exp((\exp(x) - 1)^{-1})} \cdot \rho(y) dx, \quad (11.8)$$

where $y = y(r, x) = r/R(x)$. By $r \rightarrow 0$, this function's limit for any E_2

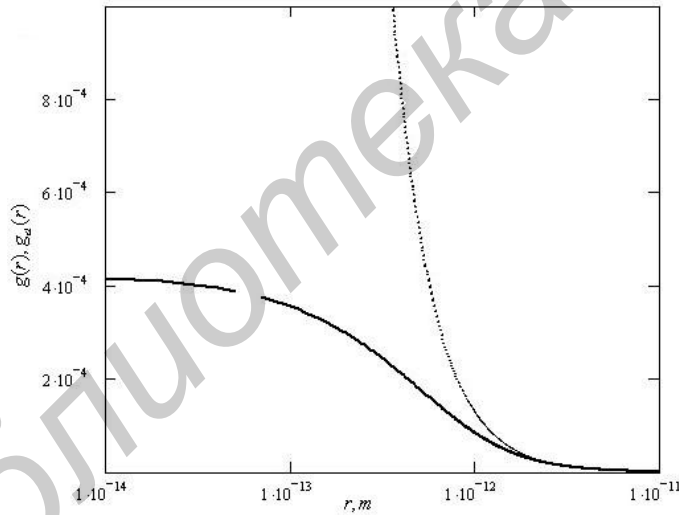

Figure 11.4: Graphs of the functions $g(r)$ (solid) and $g_{cl}(r)$ (dot) for the case $E_2 = m_p c^2$.

is: $g(r) \rightarrow I_5 = 4.24656 \cdot 10^{-4}$ [1]. Because breaking the inverse square law is described with this new function, it will be convenient to introduce the function $g_{cl}(r) \propto 1/r^2$ which differs from $g(r)$ only with the replacement: $\rho(y) \rightarrow \rho_{cl}(y)$. Graphs of these two functions, $g(r)$ and $g_{cl}(r)$, are shown

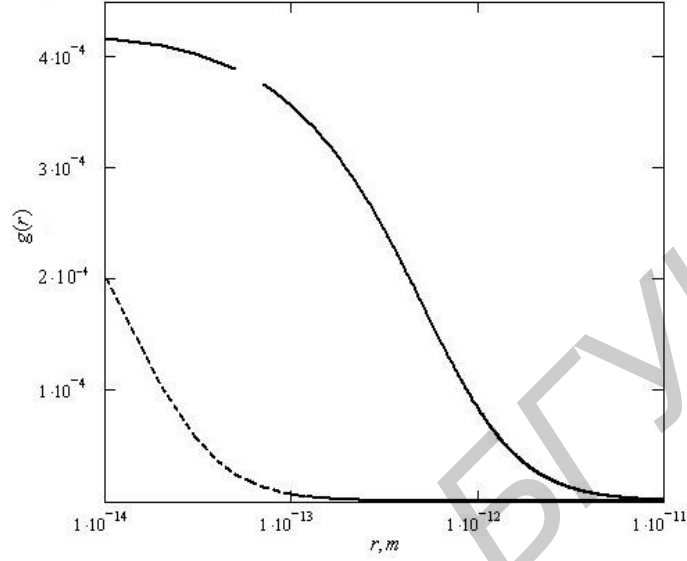

Figure 11.5: Different transition to the limit value of the function $g(r)$ by $E_2 = m_p c^2$ (solid) and by $E_2 = m_e c^2$ (dot).

in Fig. 4 for the case $E_2 = m_p c^2$. For comparison, graphs of the function $g(r)$ are shown in Fig. 5 for the following different energies: $E_2 = m_p c^2$ and $E_2 = m_e c^2$. The functions have the same limit by $r \rightarrow 0$, but the most interesting thing is their different transition to this limit when r decreases.

To underline this non-universal behavior, we can compute the ratio:

$$\eta(r) \equiv g(r)/g_d(r), \quad (11.9)$$

which aims to unity by big r . Graphs of this function $\eta(r)$ are shown in Fig. 6 for the same energies: $E_2 = m_p c^2$ and $E_2 = m_e c^2$. As we see in this picture, the range of transition for a proton is between $10^{-11} - 10^{-13}$ meter, while for an electron it is between $10^{-13} - 10^{-15}$ meter. So as $y(r, x) = r/R(x) \propto r/E_2^{0.5}$, it is obvious that the functions $g(r/E_2^{0.5})$ and $\eta(r/E_2^{0.5})$ are universal for any energy E_2 of a micro-particle. This scaling law means, for example, that if deviations from the inverse square law begins for a proton at $r_0 \sim 10^{-11} m$, then for a particle with an energy of E_{2x} , the same deviations appear at $r_{0x} = r_0 \cdot (E_{2x}/m_p c^2)^{0.5}$.

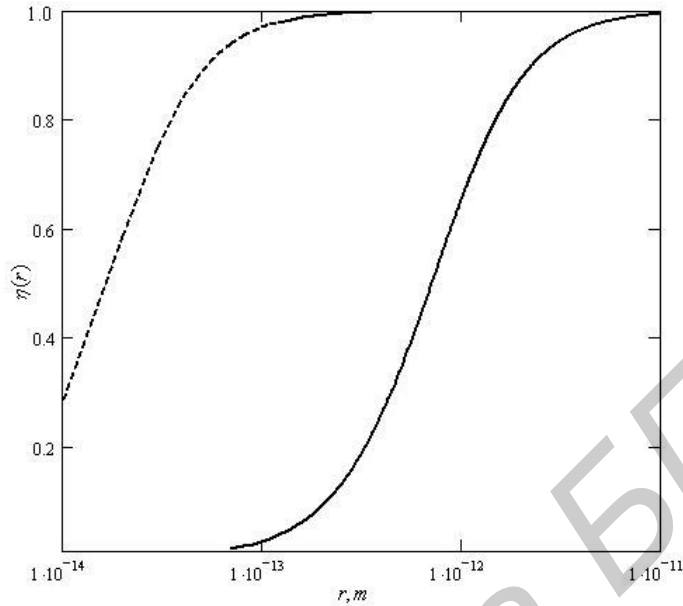

Figure 11.6: A non-universal transition to the limit value of unity of the function $\eta(r)$ by $E_2 = m_p c^2$ (solid) and by $E_2 = m_e c^2$ (dot).

11.4 Conclusion

The considered model has the two unexpected properties: asymptotic freedom and a non-universal transition to it. As distinct from QCD, at very small distances the attractive force of gravitation doesn't decrease when $r \rightarrow 0$, instead, it remains only finite and very small - but its limit value is the maximal possible one. Perhaps, it would be better to say that gravity between micro-particles gets a saturation at short distances in this model.

Bibliography

- [1] Ivanov, M.A. [arXiv:0801.0291v3 [hep-th]].
- [2] Ivanov, M.A. Gravitons as super-strong interacting particles, and low-energy quantum gravity. In the book "Focus on Quantum Gravity Research", Ed. D.C. Moore, Nova Science, New York, 2006, pp. 89-120; [hep-th/0506189], [<http://ivanovma.narod.ru/nova04.pdf>].
- [3] D. J. Gross, F. Wilczek, Phys. Rev. Letters 30 (1973) 1343-1346.
- [4] H. D. Politzer, Phys. Rev. Letters 30 (1973) 1346-1349.
- [5] Ivanov, M.A. Contribution to the Conference "Thinking, Observing and Mining the Universe" (Thinking2003), 22-27 Sep 2003, Sorrento, Italy; [astro-ph/0309566].

Chapter 12

How to verify the redshift mechanism of low-energy quantum gravity

¹

In the model of low-energy quantum gravity by the author, the redshift mechanism is quantum and local, and it is not connected with any expansion of the Universe. A few possibilities to verify its predictions are considered here: the specialized ground-based laser experiment; a deceleration of massive bodies and the Pioneer anomaly; a non-universal character of the Hubble diagram for soft and hard radiations; galaxy/quasar number counts.

12.1 Introduction

Many people consider the discovery of dark energy to be the main finding of present cosmology. They are sure that an existence of dark energy has been proved with observations of new, precise, era of cosmology, and it is necessary only to clarify what it adds up. Because of this, new cosmological centers are created and addicted to this main goal. It seems to me that a new scientific myth has risen in our eye; it is nice, almost commonly accepted, with global consequences for physics, but it is really based on nothing. What was a base for its rising? In 1998, two teams of astrophysicists reported

¹In the Proceedings of the Int. conference Problems of Practical Cosmology, 23-27 June 2008, Saint Petersburg, Russia. [arXiv:0809.1849v1 [physics.gen-ph]]

about dimming remote SN 1a [1, 2]; the one cannot be explained in the standard cosmological model on a basis of the Doppler effect if the universe expands with deceleration. Their conclusion that the Universe expands with acceleration since some cosmological time served a base to endenizen dark energy. But this conclusion is not a single possible one; if the model does not fit observations, probably, the one may simply be wrong.

If we stay on such the alternative point of view, what should namely be doubt in the standard cosmological model? I think that it should be at first its main postulate: a red shift is caused with an expansion of the Universe. If this postulate is wrong, then the whole construction of the model will wreck: neither the Big Bang nor inflation, nor a temp or character of expansion would not be interested. In the model of low-energy quantum gravity by the author [3], the alternative redshift mechanism is quantum and local. I review here a few possibilities to verify its predictions.

12.2 Possibilities to verify the alternative redshift mechanism

In my model [3], any massive body must experience a constant deceleration $w \simeq -Hc$, where H is the Hubble constant and c is the light velocity, of the same order of magnitude as observed for NASA deep-space probes Pioneer 10/11 (the Pioneer anomaly) [4, 5]. This effect is an analogue of cosmological redshifts in the model. Their common nature is forehead collisions with gravitons. If my conjecture about the quantum nature of this acceleration is true then an observed value of the projection of the probe's acceleration on the sunward direction w_s should depend on accelerations of the probe, the Earth and the Sun relative to the graviton background. It would be very important to confront the considered model with observations for small distances when Pioneer 11 executed its planetary encounters with Jupiter and Saturn. In this period, *the projection of anomalous acceleration may change its sign* [6].

How to verify the main conjecture of this approach about the quantum gravitational nature of redshifts in a ground-based laser experiment? If the temperature of the background is $T = 2.7K$, the tiny satellite of main laser line of frequency ν after passing the delay line will be red-shifted at $\sim 10^{-3}$ eV/h and its position will be fixed [7]. It will be caused by the fact that on

a very small way in the delay line only a small part of photons may collide with gravitons of the background. The rest of them will have unchanged energies. The center-of-mass of laser radiation spectrum should be shifted proportionally to a photon path l . Then due to the quantum nature of shifting process, the ratio of satellite's intensity to main line's intensity should have the order: $\sim (h\nu/\bar{\epsilon})(H/c)l$, where $\bar{\epsilon}$ is an average graviton energy. An instability of a laser of a power P should be only $\ll 10^{-3}$ if a photon energy is of ~ 1 eV. It will be necessary to compare intensities of the red-shifted satellite at the very beginning of the path l and after it. Given a very low signal-to-noise ratio, one could use a single photon counter to measure the intensities. When q is a quantum output of a cathode of a used photomultiplier, N_n is a frequency of its noise pulses, and n is a desired ratio of a signal to noise's standard deviation, then an evaluated time duration t of data acquisition would have the order: $t = (\bar{\epsilon}^2 c^2 / H^2)(n^2 N_n / q^2 P^2 l^2)$. Assuming $n = 10$, $N_n = 10^3$ s⁻¹, $q = 0.3$, $P = 100$ mW, $l = 100$ m, we would have the estimate: $t = 200,000$ years, that is unacceptable. But given $P = 300$ W, we get: $t \sim 8$ days, that is acceptable for the experiment of such the potential importance. Of course, one will rather choose a bigger value of l by a small laser power forcing a laser beam to whipsaw many times between mirrors in a delay line - it is a challenge for experimentalists. Maybe, it will be more convenient to work with high-energy gamma rays to search for this effect in a manner similar to the famous Pound-Rebka experiment [8].

The luminosity distance in this model is [3]: $D_L = a^{-1} \ln(1+z) \cdot (1+z)^{(1+b)/2}$, where $a = H/c$, z is a redshift. The theoretical value of relaxation factor b has been found in the assumption that in any case of a non-forehead collision of a graviton with a photon, the latter leaves a photon flux detected by a remote observer: $b = 2.137$. It is obvious that this assumption should be valid for a soft radiation when a photon deflection angle is big enough and collisions are rare. It is easy to find a value of the factor b in another marginal case - for a very hard radiation. Due to very small ratios of graviton to photon momenta, photon deflection angles will be small, but collisions will be frequent because the cross-section of interaction is a bilinear function of graviton and photon energies in this model. It means that in this limit case $b \rightarrow 0$. For an arbitrary source spectrum, a value of the factor b should be still computed, and it will not be a simple task. It is clear that $0 \leq b \leq 2.137$, and in a general case it should depend on a rest-frame spectrum and on a redshift. It is important that the Hubble diagram is a multivalued function of a redshift: *for a given z , b may have different values*. Theoretical distance

moduli $\mu_0(z) = 5 \log D_L + 25$ are shown in Fig. 1 for $b = 2.137$ (solid), $b = 1$ (dot) and $b = 0$ (dash) [9]. If this model is true, all observations should lie in the stripe between lower and upper curves. For Fig. 1, supernova

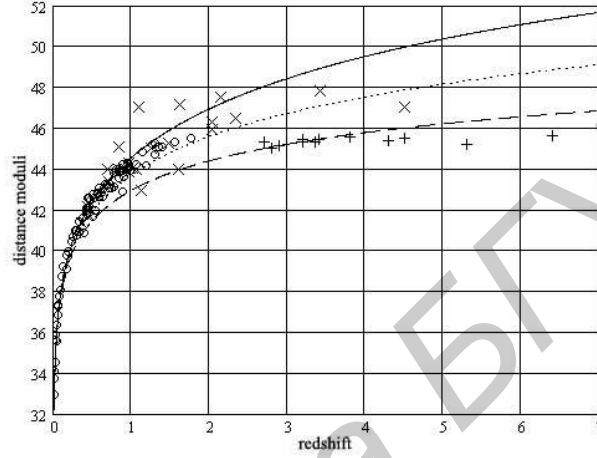

Figure 12.1: Hubble diagrams $\mu_0(z)$ with $b = 2.137$ (solid), $b = 1$ (dot) and $b = 0$ (dash); supernova observational data (circles, 82 points) are taken from Table 5 of [10], gamma-ray burst observations are taken from [11] (x, 24 points) and from [12] (+, 12 points for $z > 2.6$).

observational data (circles, 82 points) are taken from Table 5 of [10], gamma-ray burst observations are taken from [11] (x, 24 points) and from [12] (+, 12 points for $z > 2.6$). As it was recently shown by Cuesta et al. [13], the Hubble diagram with $b = 1$ (in the language of this paper) gives the best fit to the full sets of gamma-ray burst observations of [11, 12] and it takes place in the standard FLRW cosmology plus the strong energy condition. Twelve observational points of [12] belong to the range $z > 2.6$, and one can see that these points peak up the curve with $b = 0$ which corresponds in this model to the case of very hard radiation in the non-expanding Universe with a flat space. In a frame of models without expansion, any red-shifted source may not be brighter than it is described with this curve.

In this model, the galaxy number counts/magnitude relation is [?]: $f_3(m) = (\phi_* \kappa / a^3) \cdot m \cdot \int_0^{z_{max}} l^{\alpha+1}(m, z) \cdot \exp(-l(m, z)) \cdot (\ln^2(1+z)/(1+z)) dz$. To compare this function with observations by Yasuda et al. [14], let us choose the normalizing factor from the condition: $f_3(16) = a(16)$, where $a(m) \equiv A_\lambda \cdot 10^{0.6(m-16)}$ is the function assuming "Euclidean" geometry and giving

the best fit to observations [14], $A_\lambda = \text{const}$ depends on the spectral band; an upper limit is $z_{max} = 10$. In this case, we have two free parameters - α and L_* - to fit observations, and the latter one is connected with a constant $A_1 \equiv A/a^2 L_*$ if $l(m, z) = A_1 f_1^2(z)/\kappa^m$. We have for A_1 by $H = 2.14 \cdot 10^{-18} \text{ s}^{-1}$ (it is a theoretical estimate of H in this model [3]): $A_1 \simeq 5 \cdot 10^{17} \cdot (L_\odot/L_*)$, where L_\odot is the Sun luminosity. Matching values of α shows that $f_3(m)$ is the closest to $a(m)$ in the range $10 < m < 20$ by $\alpha = -2.43$. The ratio $(f_3(m) - a(m))/a(m)$ is shown in Fig. 2 for different values of A_1 by this value of α . If we compare this figure with Figs. 6,10,12 from [14], we see that the

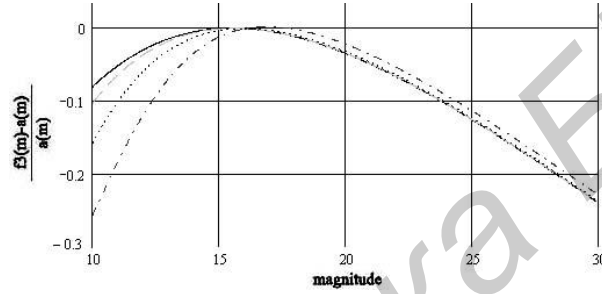

Figure 12.2: The relative difference $(f_3(m) - a(m))/a(m)$ as a function of the magnitude m for $\alpha = -2.43$ by $10^{-2} < A_1 < 10^2$ (solid), $A_1 = 10^4$ (dash), $A_1 = 10^5$ (dot), $A_1 = 10^6$ (dadot).

considered model provides a no-worse fit to observations than the function $a(m)$ if the same K-corrections are added for the range $10^2 < A_1 < 10^7$ that corresponds to $5 \cdot 10^{15} > L_* > 5 \cdot 10^{10}$. *Observations prefer a rising behavior of this ratio up to $m = 16$, and the model demonstrates it.*

For quasars, I computed the galaxy number counts/redshift relation $f_5(m, z)$ with a different (than for galaxies) luminosity function $\eta'(l(m, z))$ [9]. In Fig 3, there are a couple of curves for each case: the left-shifted curve of any couple (1' - 5') corresponds to the range $16 < m < 18.25$, another one (1 - 5) corresponds to $18.25 < m < 20.85$. These ranges are chosen the same as in the paper by Croom et al. [15], and you may compare this figure with Fig. 3 in [15]. We can see that the theoretical distributions reflect only some features of the observed ones but not an entire picture. Perhaps, it is necessary to consider some theoretical model of a quasar activity to get a distribution of "instantaneous" luminosities (a couple of simple examples is considered in [9]).

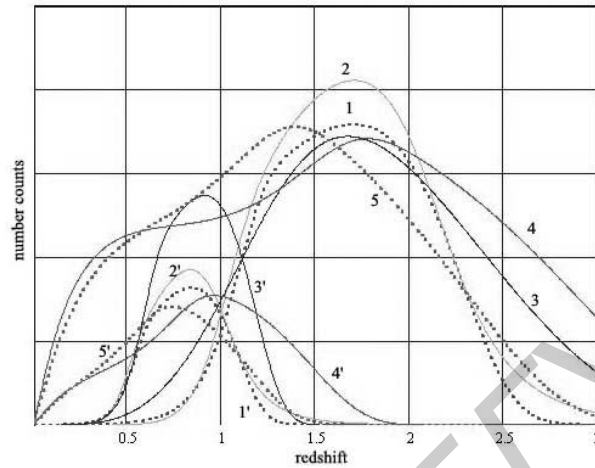

Figure 12.3: QSO number counts $f_5(m, z)$ (arbitrary units) as a function of the redshift for different luminosity functions: Gaussian (1', 1 dot), the double power law (2', 2), Schechter's (3', 3), combined (4', 4 solid and 5', 5 dot) with parameters given in the text of [9]. The left-shifted curve of each couple (1' - 5') corresponds to the range $16 < m < 18.25$, another one (1 - 5) corresponds to $18.25 < m < 20.85$.

12.3 Conclusion

One can verify the quantum and local redshift mechanism of this model in different ways, but I think that the most cogent one would be the described prompt measurement of a possible length-dependent red shift of radiation spectrum in the laboratory experiment. A negative result of this experiment would be a very strong support of the standard cosmological model; a positive one might open the door not only for new cosmology, but for otherwise quantum gravity, too.

Bibliography

- [1] Riess, A.G. et al. *AJ* 1998, *116*, 1009.
- [2] Perlmutter, S. et al. *ApJ* 1999, *517*, 565.
- [3] Ivanov, M.A. In the book "Focus on Quantum Gravity Research", Ed. D.C. Moore, Nova Science, NY, 2006, pp. 89-120; [hep-th/0506189], [<http://ivanovma.narod.ru/nova04.pdf>].
- [4] Anderson, J.D. et al. *Phys. Rev. Lett.* 1998, *81*, 2858.
- [5] Anderson, J.D. et al. *Phys. Rev.* 2002, *D65*, 082004; [gr-qc/0104064 v4].
- [6] Ivanov, M.A. [arXiv:0711.0450v2] [physics.gen-ph] (see Chapter 10).
- [7] Ivanov, M.A. [gr-qc/0410076] (see Chapter 5).
- [8] Pound, R. V.; Rebka Jr., G. A. *Phys. Rev. Lett.* 1959, *3*, 439; 1960, *4*, 337.
- [9] Ivanov, M.A. [astro-ph/0606223] (see Chapter 8).
- [10] Riess, A.G. et al. *ApJ*, 2004, *607*, 665; [astro-ph/0402512].
- [11] Bloom, J.S., Frail, D.A., and Kulkarni, S.R. *ApJ*, 2003, *594*, 674.
- [12] Schaefer, B.E. *BAAS*, 2005, *37*, 1418; 207 AAS Meeting, 2006.
- [13] Cuesta, H.J.M. et al. [astro-ph/0609262].
- [14] N. Yasuda et al., *AJ* 2001, *122*, 1104.

- [15] Croom, S.M. et al. MNRAS, 2004, 349, 1397.

Библиотека БГУИР

Chapter 13

Lorentz symmetry violation due to interactions of photons with the graviton background

¹

The average time delay of photons due to multiple interactions with gravitons of the background is computed in a frame of the model of low-energy quantum gravity by the author. The two variants of evaluation of the lifetime of a virtual photon are considered: 1) on a basis of the uncertainties relation (it is a common place in physics of particles) and 2) using a conjecture about constancy of the proper lifetime of a virtual photon. It is shown that in the first case Lorentz violation is negligible: the ratio of the average time delay of photons to their propagation time is equal approximately to 10^{-28} ; in the second one (with a new free parameter of the model), the time-lag is proportional to the difference $\sqrt{E_{01}} - \sqrt{E_{02}}$, where E_{01} , E_{02} are initial energies of photons, and more energetic photons should arrive later, also as in the first case. The effect of graviton pairing is taken into account, too.

13.1 Introduction

Lorentz invariance is the cornerstone of physics of elementary particles, and a degree of its possible violation is of a great interest (see the review [1]). Possible Lorentz violation is often connected in our minds with quantum gravity

¹[arXiv:0907.1032v2 [physics.gen-ph]]

effects; and it is almost commonly accepted that these effects should reveal themselves at the Plank scales of energies and distances. It is another story that dealing with the Plank scale of distances suggests that our knowledge of gravity (general relativity) is true up to this scale [2]; but it is not a proofed fact. I would like to cite the recent paper [3] as a typical one in this direction; the authors speak about days or months of time-lags for photons of GRB's in some theoretical cases.

But in my model of low-energy quantum gravity [4], gravity reveals asymptotic freedom at very short distances beginning from $10^{-11} - 10^{-13}$ meter for different particles [5], i.e. very-very far from the Plank scale. In this paper, I have computed the average time delay of photons due to multiple interactions with gravitons of the background in a frame of the model [4]. The two variants of evaluation of the lifetime of a virtual photon are considered: 1) on a basis of the uncertainties relation (it is a common place in physics of particles) and 2) using a conjecture about constancy of the proper lifetime of a virtual photon. It is shown that in the first case Lorentz violation is negligible; in the second one (with a new free parameter of the model), the time-lag is proportional to the difference $\sqrt{E_{01}} - \sqrt{E_{02}}$, where E_{01} , E_{02} are initial energies of photons, and more energetic photons should arrive later, also as in the first case. The effect of graviton pairing is taken into account, too.

13.2 Time delay of photons due to interactions with gravitons

To compute the average time delay of photons in the model [4], it is necessary to find a number of collisions with gravitons of the graviton background on a small way dr and to evaluate a delay due to one act of interaction. Let us consider at first the background of single gravitons. Given the expression for H in the model, we can write for the number of collisions with gravitons having an energy $\epsilon = \hbar\omega$:

$$dN(\epsilon) = \frac{|dE(\epsilon)|}{\epsilon} = E(r) \cdot \frac{dr}{c} \frac{1}{2\pi} Df(\omega, T)d\omega, \quad (13.1)$$

where $f(\omega, T)$ is described by the Plank formula. In the forehead collision, a photon loses the momentum ϵ/c and obtains the energy ϵ ; it means that for

a virtual photon we will have:

$$\frac{v}{c} = \frac{E - \epsilon}{E + \epsilon}; \quad 1 - \frac{v}{c} = \frac{2\epsilon}{E + \epsilon}; \quad 1 - \frac{v^2}{c^2} = \frac{4\epsilon E}{(E + \epsilon)^2}. \quad (13.2)$$

13.2.1 Evaluation of the lifetime of a virtual photon on a basis of the uncertainties relation

The uncertainty of energy for a virtual photon is equal to $\Delta E = 2\epsilon$. If we evaluate the lifetime using the uncertainties relation: $\Delta E \cdot \Delta\tau \geq \hbar/2$, we get $\Delta\tau \geq \hbar/4\epsilon$. So as during the same time $\Delta\tau$ real photons overpass the way $c\Delta\tau$, and virtual ones overpass only the way $v\Delta\tau$, we have:

$$c\Delta t = c\Delta\tau - v\Delta\tau,$$

where Δt is the time delay, and the last one will be equal to:

$$\Delta t(\epsilon) = \Delta\tau(1 - \frac{v}{c}) \geq \hbar/2 \cdot \frac{1}{E + \epsilon}. \quad (13.3)$$

The full time delay due to gravitons with an energy ϵ is: $dt(\epsilon) = \Delta t(\epsilon)dN(\epsilon)$. Taking into account all frequencies, we find the full time delay on the way dr :

$$dt \geq \int_0^\infty \frac{\hbar}{2} \frac{E}{E + \epsilon} \cdot \frac{dr}{c} \frac{1}{2\pi} Df(\omega, T) d\omega. \quad (13.4)$$

The one will be maximal for $E \rightarrow \infty$, and it is easy to evaluate it:

$$dt_\infty \geq \frac{\hbar}{4\pi} \frac{dr}{c} \cdot D\sigma T^4. \quad (13.5)$$

On the way r the time delay is:

$$t_\infty(r) \geq \frac{\hbar}{4\pi} \frac{r}{c} \cdot D\sigma T^4. \quad (13.6)$$

In this model: $r(z) = c/H \cdot \ln(1 + z)$; let us introduce a constant $\rho \equiv \hbar/4\pi \cdot D\sigma T^4/H = 37.2 \cdot 10^{-12} s$, then

$$t_\infty(z) \geq \rho \ln(1 + z). \quad (13.7)$$

We see that for $z \simeq 2$ the maximal time delay is equal to ~ 40 ps, i.e. the one is negligible.

In the rest frame of a virtual photon, a single parameter, which may be juxtaposed with an energy uncertainty, is mc^2 . Accepting $\Delta E = mc^2$ in this frame, we'll get:

$$t(z) \geq \rho/2 \cdot \ln(1+z) \quad (13.8)$$

with the same ρ ; now this estimate doesn't depend on E .

13.2.2 The case of constancy of the proper lifetime of a virtual photon

Taking into account that for a virtual photon after a collision $(E'/c)^2 - p'^2 > 0$, we may consider another possibility of lifetime estimation, for example, $\Delta\tau_0 = \text{const}$, where $\Delta\tau_0$ is the proper lifetime of a virtual photon (it should be considered as a new parameter of the model). Now it is necessary to transit to the reference frame of observer:

$$\Delta\tau = \Delta\tau_0 / (1 - \frac{v^2}{c^2})^{1/2} = \Delta\tau_0 \cdot \frac{E + \epsilon}{2\sqrt{\epsilon E}}, \quad (13.9)$$

accordingly:

$$\Delta t(\epsilon) = \Delta\tau(1 - \frac{v}{c}) = \Delta\tau_0 \cdot \sqrt{\epsilon/E}. \quad (13.10)$$

Then the full time delay due to gravitons with an energy ϵ is:

$$dt(\epsilon) = \Delta t(\epsilon) dN(\epsilon) = \Delta\tau_0 \cdot \sqrt{\epsilon E} \cdot \frac{dr}{c} \frac{1}{2\pi} Df(\omega, T) d\omega, \quad (13.11)$$

and integrating it, we get:

$$dt = \Delta\tau_0 \cdot \sqrt{E(r)} \cdot \frac{dr}{c} \frac{1}{2\pi} D \int_0^\infty \sqrt{\epsilon} f(\omega, T) d\omega. \quad (13.12)$$

The integral in this expression is equal to:

$$\int_0^\infty \sqrt{\epsilon} f(\omega, T) d\omega \equiv \frac{1}{4\pi^2 c^2} \cdot \frac{(kT)^{9/2}}{\hbar^3} \cdot I_6, \quad (13.13)$$

where a new constant I_6 is the following integral:

$$I_6 \equiv \int_0^\infty \frac{x^{7/2} dx}{\exp x - 1} = 12.2681. \quad (13.14)$$

In this model, the energy of a photon decreases as [4]: $E(r) = E_0 \exp(-Hr/c)$. The full delay on the way r now is:

$$\begin{aligned} t(r) &= \Delta\tau_0 \cdot \frac{D}{8\pi^3 c^2} \cdot \frac{(kT)^{9/2}}{\hbar^3} \cdot I_6 \int_0^r \sqrt{E(r')} \cdot \frac{dr'}{c} = \\ &= \Delta\tau_0 \cdot \frac{D}{8\pi^3 c^2} \cdot \frac{(kT)^{9/2}}{\hbar^3} \cdot I_6 \cdot \frac{2}{H} \cdot (\sqrt{E_0} - \sqrt{E(r)}). \end{aligned} \quad (13.15)$$

Let us introduce a new constant ϵ_0 for which:

$$\frac{1}{\sqrt{\epsilon_0}} \equiv \frac{D}{8\pi^3 c^2} \cdot \frac{(kT)^{9/2}}{\hbar^3} \cdot I_6 \cdot \frac{2}{H},$$

so $\epsilon_0 = 2.391 \cdot 10^{-4} \text{ eV}$, then

$$t(r) = \frac{\Delta\tau_0}{\sqrt{\epsilon_0}} \cdot (\sqrt{E_0} - \sqrt{E(r)}) = \Delta\tau_0 \sqrt{\frac{E_0}{\epsilon_0}} \cdot (1 - \exp(-Hr/2c)), \quad (13.16)$$

where E_0 is an initial photon energy. This delay as a function of redshift is:

$$t(z) = \Delta\tau_0 \sqrt{\frac{E_0}{\epsilon_0}} \cdot \frac{\sqrt{1+z} - 1}{\sqrt{1+z}}. \quad (13.17)$$

In this case, the time-lag between photons emitted in one moment from the same source with different initial energies E_{01} and E_{02} will be proportional to the difference $\sqrt{E_{01}} - \sqrt{E_{02}}$, and more energetic photons should arrive later, also as in the first case. To find $\Delta\tau_0$, we must compare the computed value of time-lag with future observations. An analysis of time-resolved emissions from the gamma-ray burst GRB 081126 [6] showed that the optical peak occurred $(8.4 \pm 3.9) \text{ s}$ later than the second gamma peak; perhaps, it means that this delay is connected with the mechanism of burst.

13.2.3 An influence of graviton pairing

Graviton pairing of existing gravitons of the background is a necessary stage to ensure the Newtonian attraction in this model [7]. As it has been shown in the cited paper, the spectrum of pairs is the Planckian one, too, but with the smaller temperature $T_2 \equiv 2^{-3/4}T$; this spectrum may be written as: $f(\omega_2, T_2)d\omega_2$, where $\omega_2 \equiv 2\omega$. Then residual single gravitons will have

the new spectrum: $f(\omega, T)d\omega - f(\omega_2, T_2)d\omega_2$, and we should also take into account an additional contribution of pairs into the time delay.

We shall have now:

$$dN(\epsilon) = E(r) \cdot \frac{dr}{c} \frac{1}{2\pi} D(f(\omega, T)d\omega - f(\omega_2, T_2)d\omega_2), \quad (13.18)$$

and for pairs with energies 2ϵ :

$$dN(2\epsilon) = \frac{|dE(2\epsilon)|}{2\epsilon} = E(r) \cdot \frac{dr}{c} \frac{1}{2\pi} Df(\omega_2, T_2)d\omega_2. \quad (13.19)$$

After a collision of a photon with a pair, a virtual photon will have a velocity v_2 : $v_2/c = (E - 2\epsilon)/(E + 2\epsilon)$, and a mass m_2 : $m_2c^2 = 2\sqrt{2\epsilon E}$.

For the case of subsection 2.1, after collisions with pairs: $\Delta E = 4\epsilon$, $\Delta\tau \geq \hbar/8\epsilon$, and we get:

$$\Delta t(2\epsilon) \geq \hbar/2 \cdot \frac{1}{E + 2\epsilon}. \quad (13.20)$$

Then due to single gravitons and pairs:

$$dt_2(\epsilon) = dt'(\epsilon) + dt(2\epsilon) \geq dt(\epsilon) - \hbar/2 \cdot \frac{\epsilon E}{(E + \epsilon)(E + 2\epsilon)} \cdot \frac{dr}{c} \frac{1}{2\pi} Df(\omega_2, T_2)d\omega_2, \quad (13.21)$$

where $dt'(\epsilon)$ is a reduced contribution of single gravitons, $dt(\epsilon)$ is its full contribution corresponding to formula (4). We see that if one takes into account graviton pairing, the estimate of delay became smaller. So as

$$\epsilon E / (E + \epsilon)(E + 2\epsilon) \rightarrow 0$$

by $\epsilon/E \rightarrow 0$, we have for the maximal delay in this case: $t_{2\infty}(r) \rightarrow t_\infty(r)$, i.e. the maximal delay is the same as in subsection 2.1.

Repeating the above procedure for the case of subsection 2.2, we shall get:

$$t_2(r) = [1 + (1 - 1/\sqrt{2}) \cdot (T_2/T)^{9/2}] \cdot t(r) \simeq 1.028 \cdot t(r), \quad (13.22)$$

where $t_2(r)$ takes into account graviton pairing, and $t(r)$ is described by formula (16). In this case, the full delay is bigger on about 2.8% than for single gravitons.

13.3 Conclusion

Because in this model the propagation time for photons as a function of redshift is: $t(z) = r(z)/c = 1/H \cdot \ln(1 + z)$, the ratio of the average time delay of photons to their propagation time is equal approximately to 10^{-28} and doesn't depend on z in the first considered case. This very small quantity characterizes the degree of Lorentz violation in the model for the usually accepted manner of the lifetime evaluation. Even for remote astrophysical sources time-lags will be of the order of tens picoseconds, i.e. unmeasurable, and one may consider Lorentz symmetry as an exact one for any laboratory experiment. If the second considered case is realized in the nature, one should initially evaluate the free parameter of the model $\Delta\tau_0$ from observations.

Some preliminary results of this work were used in my paper [8].

Bibliography

- [1] Liberati, S., and Maccione, L. [arXiv:0906.0681v1 [astro-ph.HE]]
- [2] Gorelik, G. *Studies in the history of general relativity*. [Einstein Studies, Vol. 3]. Eds. Jean Eisenstaedt, A.J. Kox. Boston: Birkhaeuser, 1992, pp. 364-379.
- [3] Amelino-Camelia, G., and Smolin, L. [arXiv:0906.3731v2 [astro-ph.HE]].
- [4] Ivanov, M.A. In the book "Focus on Quantum Gravity Research", Ed. D.C. Moore, Nova Science, NY, 2006, pp. 89-120; [hep-th/0506189], [<http://ivanovma.narod.ru/nova04.pdf>].
- [5] Ivanov, M.A. *J. Grav. Phys.*, 2008, V.2, No.2, pp. 26-31; [arXiv:0801.1973v1 [hep-th]] (see Chapter 11).
- [6] Klotz, A. et al. *ApJ Lett.* 697 (2009) L18; [arXiv:0904.4786v1 [astro-ph.CO]].
- [7] Ivanov, M.A. [gr-qc/0207006] (see Chapter 3).
- [8] Ivanov, M.A. [arXiv:0905.4028v1 [physics.gen-ph]].

Chapter 14

No-time-dilation corrected Supernovae 1a and GRBs data and low-energy quantum gravity

¹

Earlier it was shown that in the model of low-energy quantum gravity by the author, observations of Supernovae 1a and GRBs, which are corrected by observers for characteristic for the standard cosmological model time dilation, may be fitted with the theoretical luminosity distance curve only up to $z \sim 0.5$, for higher redshifts the predicted luminosity distance is essentially bigger. The model itself has not time dilation due to another redshift mechanism. It is shown here that a correction of observations for no time dilation leads to a good accordance of observations and theoretical predictions for all achieved redshifts.

14.1 Introduction

A main element of the universe in the model of low-energy quantum gravity by the author [1, 2, 3] is the background of super-strong interacting gravitons. A pressure force of the background creates gravitation, and the Newton

¹Contribution to the VI Int. Workshop on the Dark side of the Universe (DSU2010), Guanajuato U., Leon, Mexico, 1-6 June, 2010. [<http://vixra.org/abs/1006.0012>]

constant is computable in the model. From another side, collisions of photons with gravitons lead to a redshift of any remote object and to a specific relaxation of any light flux. The Hubble constant may be computed, too; it is not connected here with any expansion. The luminosity distance of the model increases quickly with a redshift, and any observer sees only a part of the big universe, when an invisible part of the one remains unknown.

I would like to describe here a result of correction of observations of Supernovae 1a and GRBs for no time dilation. This effect is absent in the model, but observations are usually corrected for it in a frame of the standard model; it means that a comparison of any model without time dilation and corrected in this manner observations is not valid in any case.

14.2 Correction for no time delation

In the standard cosmological model, the expansion of the Universe leads to the time dilation of $(1 + z)$; due to it, for example, light curves of Supernovae 1a are contracted along the time axis by $(1 + z)$ to return them to the rest frame [4, 5]. Nearby Supernovae 1a diversity may be taken into account with the help of the stretch factor s [4]: a fainter SN has $s < 1$, a brighter SN has $s > 1$, and to reduce them to a normal SN with $s = 1$, one should contract both quantities - the timescale and the magnitude of supernova light curve - in s times. This calibration relation was found empirically. High- z Supernovae light curves are characterized by observers with the timescale stretch factor $S = s \cdot (1 + z)$, where the factor $(1 + z)$ takes into account the effect of time dilation in the standard model [4]. The latter factor is introduced by hand. Now the timescale of light curve is corrected by the factor S , when its magnitude is corrected only by the stretch factor s . But the specific correction for the additional $(1 + z)$ time-dilation factor - expected only in this class of models - is not needed in any model without time dilation. It means, that in models without time dilation one should use the same stretch factor S to correct the two quantities of the light curve. Of course, the question arises about possible differences of distributions of values of s and S for nearby and high- z Supernovae, but it is another story.

The luminosity distance D_L is defined as: $D_L = (L/4\pi F)^{1/2}$, where L and F are the intrinsic luminosity and observed flux of the SN 1a. If the observed flux is overestimated in $(1 + z)$ times due to the described correction for time dilation, one should correct distance moduli $\mu_0 = 5 \log D_L + 25$ in the

following manner [6]:

$$\mu'_0 = \mu_0 + 2.5 \log(1 + z),$$

where μ'_0 are distance moduli in any model without time dilation. In this model, the luminosity distance is

$$D_L = a^{-1} \ln(1 + z) \cdot (1 + z)^{(1+b)/2},$$

where $a = H/c$, H is the Hubble constant and c is the light velocity. The theoretical value of relaxation factor b for a soft radiation is $b = 2.137$. The theoretical Hubble diagram of this model with $b = 2.137$ is compared with observational data by Riess et al [7] on Fig.1; if you compare this figure with Fig.2 of [3] where the same data are shown with time dilation correction, you may see that all the difference with theoretical predictions was caused namely by time dilation which is not "native" for this model.

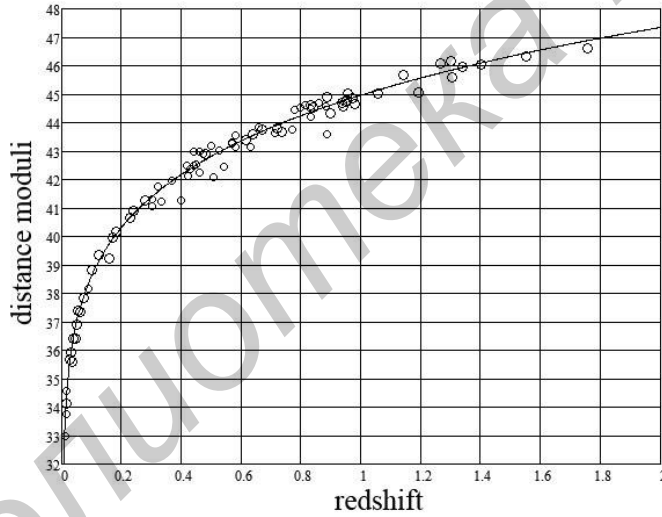

Figure 14.1: The theoretical Hubble diagram $\mu_0(z)$ of this model with $b = 2.137$ (solid); Supernovae 1a observational data (circles, 82 points) are taken from Table 5 of [7] and corrected for no time dilation.

The factor b of this model may have different values for soft and hard radiation [8]; the situation here differs very much from any model with the cosmological expansion. For very hard radiation, it should be: $b = 0$. Unfortunately, to evaluate distance moduli of GRBs one should use or theoretical

values of the luminosity distance or calibrate data by nearby SN1a [9]. In the latter case, it is accepted that the luminosity distance is the same for sources with different spectra that is true in models with the cosmological expansion; but in the considered model, the Hubble diagram is a multivalued function of a redshift: for a given z , b may have different values for different sources [8]. It means that GRBs data of [9] calibrated with the help of the Union 2 compilation of nearby SN1a [10] are model dependent in this sense. As

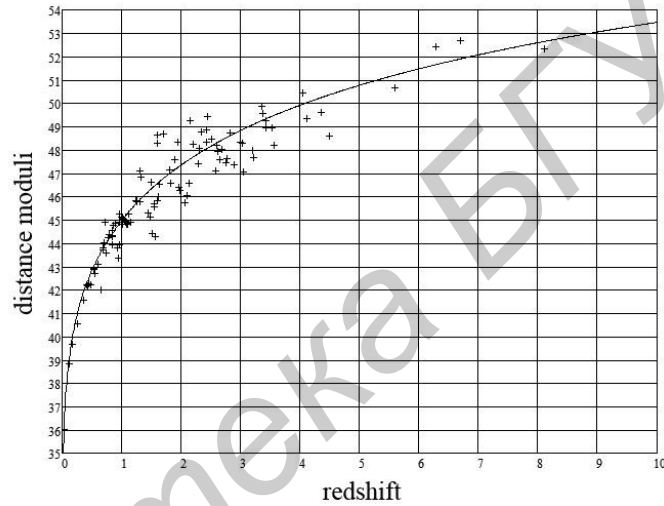

Figure 14.2: The theoretical Hubble diagram $\mu_0(z)$ of this model with $b = 2.137$ (solid); GRBs calibrated observational data (pluses, 109 points) from Tables 1 and 2 of [9] corrected for no time dilation.

you can see from Fig.2, the GRBs calibrated observational data (pluses, 109 points) from Tables 1 and 2 of [9] laid very accurately near the theoretical curve of this model with the same b after the correction for no time dilation. But it is not the last word of GRBs observations: if one is able to calibrate them in some independent of SN1a manner, we shall have a possibility to distinguish much surely this model from any model with the expansion.

14.3 Conclusion

As it is shown here, observational data of Supernovae 1a and GRBs corrected for no time dilation are in good accordance with theoretical predictions of

this model. It would mean that the discovery of dark energy in a frame of the standard cosmological model is only an artefact of the conjecture about an existence of time dilation.

Библиотека БГУИР

Bibliography

- [1] Ivanov, M.A. *General Relativity and Gravitation* 2001, 33, 479; Erratum: 2003, 35, 939; [astro-ph/0005084v2] (see Chapter 1).
- [2] Ivanov, M.A. [gr-qc/0207006] (see Chapter 3).
- [3] Ivanov, M.A. In the book "Focus on Quantum Gravity Research", Ed. D.C. Moore, Nova Science, NY - 2006 - pp. 89-120; [hep-th/0506189], [<http://ivanovma.narod.ru/nova04.pdf>].
- [4] Perlmutter, S. et al. *Bull.Am.Astron.Soc.* 1997, 29, 1351 [astro-ph/9812473v1].
- [5] Blondin, S. et al. *ApJ* 2008, 682, 724-736 [arXiv:0804.3595v1].
- [6] Brynjolfsson, Ari [astro-ph/0406437v2].
- [7] Riess, A.G. et al. *ApJ*, 2004, 607, 665; [astro-ph/0402512].
- [8] Ivanov, M.A. [astro-ph/0609518] (see Chapter 9).
- [9] Wei, Hao. [arXiv:1004.4951v1 [astro-ph.CO]].
- [10] Amanullah, R. et al. [arXiv:1004.1711v1 [astro-ph.CO]].

Chapter 15

Another possible interplay between gravitation and cosmology

1

I describe here some features of a non-geometrical approach to quantum gravity which leads to another picture of ties of gravitation and cosmology. The role of taking into account the effect of time dilation of the standard cosmological model is considered. It is shown that the correction for no time dilation leads to a good accordance of Supernovae 1a data and predictions of the considered model. The distributions of stretch factor values of Supernovae 1a for the cases of time dilation and no time dilation are discussed.

The general theory of relativity and the standard cosmological model of our time are connected very closely via the main idea of a cosmological expansion. Their interplay engenders such strange and "dark" concepts as Big Bang, inflation, dark energy and dark matter. The last of such fancies is dark flow [1]; the authors try to interpret in a frame of the standard model the observed motion of galaxy clusters as a result of interaction with another bubble of a multiverse (it is necessary to have a very hard belief in the current paradigm to introduce such the explanation as the first one). Of course, it is difficult to find some other explanation of observed flat rotation curves of galaxies and related phenomena than dark matter, but, perhaps, it is not

¹[arXiv:1003.4476v3 [physics.gen-ph]]

impossible. But in the case of inflation and dark energy, the ones are obvious buttresses of the standard model in the troubles.

There is a very small, but iron made, effect which frustrates the harmony of this connection: the Pioneer anomaly [2]. It is impossible to embed the one in a frame of general relativity; from another side, a magnitude and a sign of this effect (the probe's deceleration is approximately equal to Hc , where c is the light velocity and H is the Hubble constant) overshadow seeming successes of the current cosmological model.

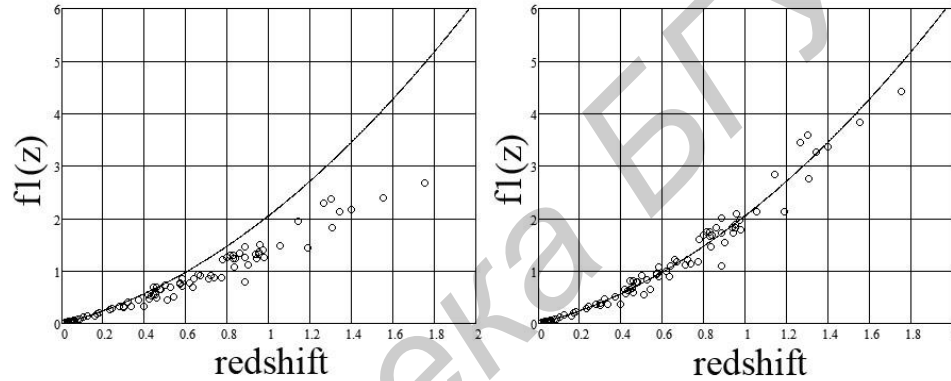

Figure 15.1: The theoretical function $f_1(z)$ of this model with $b = 2.137$ (solid); Supernovae Ia observational data from Table 5 of [10] transformed to the linear scale (circles, 82 points): corrected for time dilation (left panel) and corrected for no time dilation (right panel).

I describe here some features of a non-geometrical approach to quantum gravity [3] which leads to another interplay of gravitation and cosmology. My model is based on the idea of an existence of the background of super-strong interacting gravitons. An interaction of light with this background gives a specific redshift mechanism which does not need any cosmological expansion; its peculiarity is an additional relaxation of any light flux that may be connected with the observed deviation of the Hubble diagram from its expected view without dark energy in the standard model. Due to this relaxation, any observer can see only a part of the universe; the property is sufficient to explain the very important results of observations of a bulk flow of clusters reported in [1] without any exotic and dark names. In the model, the Newton and Hubble constants may be computed. An important feature

of the model is an essential difference of inertial and gravitational masses of black holes; it means that an existence of black holes contradicts to the equivalence principle. Additionally, the property of asymptotic freedom of this model at very short distances leads to the important consequence: a black hole mass threshold should exist [4, 5]. A full mass of black hole should be restricted from the bottom with m_0 ; the rough estimate for it is: $m_0 \sim 10^7 M_\odot$. The range of transition to gravitational asymptotic freedom for a pair of protons is between $10^{-11} - 10^{-13}$ meter, while for a pair of electrons it is between $10^{-13} - 10^{-15}$ meter. This transition is non-universal [4]; it means that a geometrical description of gravity on this or smaller scales, for example on the Planck one, is not valid. Theoretical predictions

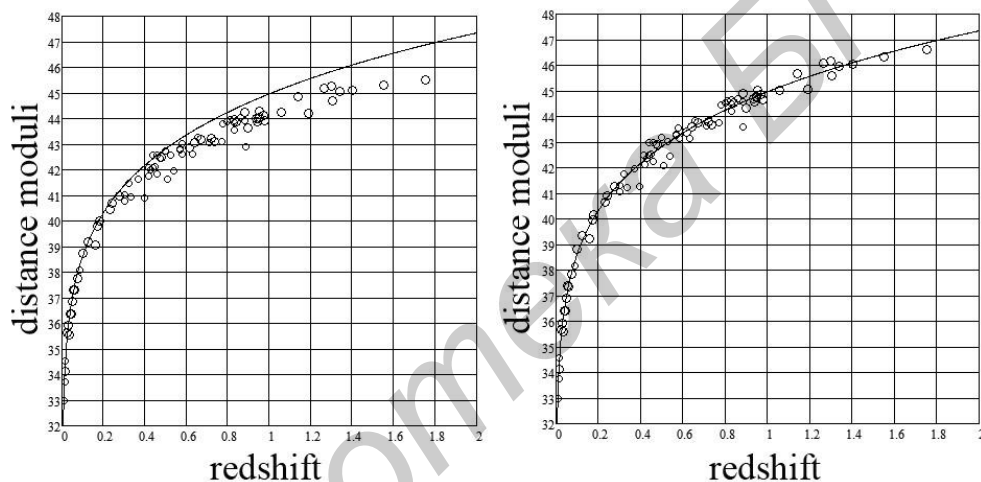

Figure 15.2: The theoretical Hubble diagram $\mu_0(z)$ of this model with $b = 2.137$ (solid); Supernovae Ia observational data from Table 5 of [10] (circles, 82 points): corrected for time dilation (left panel) and corrected for no time dilation (right panel).

for galaxy/quasar number counts were found in this model [6] based only on the luminosity distance and the geometrical one as functions of a redshift; there is not any visible contradiction with observations.

In the model, the luminosity distance D_L is equal to [3]:

$$D_L = a^{-1} \ln(1+z) \cdot (1+z)^{(1+b)/2} \equiv a^{-1} f_1(z),$$

where $f_1(z) \equiv \ln(1+z) \cdot (1+z)^{(1+b)/2}$, $a = H/c$, and $b = 2.137$ for soft radiation. Time dilation is absent in this model; but observational data are

usually corrected for this effect of the standard cosmological model [7, 8]. Due to the correction for time dilation, the observed flux is overestimated in $(1+z)$ times, and one should correct distance moduli $\mu_0 = 5 \log D_L + 25$ as [9]:

$$\mu'_0 = \mu_0 + 2.5 \log(1+z),$$

where μ'_0 are distance moduli in any model without time dilation. The comparison of predictions of the model with Supernovae 1a observational data by Riess et al. [10] is shown on Figs. 1, 2. On Fig. 1, I have used the linear scale of the vertical axis; to re-compute values of $f_1(z)$ from observations, one can apply the transformation:

$$f_1(z) = 10^{(\mu_0(z)-c_1)/5},$$

where c_1 is a constant (here its value is $c_1 = 43.4$). The left panels of these

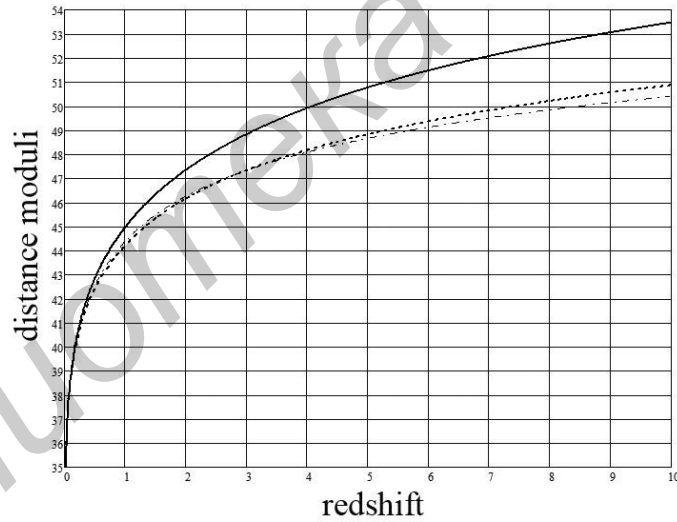

Figure 15.3: The three theoretical Hubble diagrams: $\mu_0(z)$ of this model with $b = 2.137$ (solid); $\mu_0(z)$ of this model with $b = 1.137$ taking into account the effect of time dilation of the standard model (dash); $\mu_c(z)$ for a flat Universe with the concordance cosmology by $\Omega_M = 0.27$ and $w = -1$ (dash-dotted).

figures are the same as Figs. 2, 3 of [3]; it is obvious now that the essential differences between predictions of the model and observations were caused namely by the correction for cosmological time dilation. After the correction

for no time dilation, the same observations are fitted very well with the theoretical curve (the right panels). Some further details may be found in my recent paper [11].

As it was shown in [12], theoretical distance moduli $\mu_c(z)$ for a flat Universe with the concordance cosmology by $\Omega_M = 0.27$ and $w = -1$, which give the best fit to GRB observations by Schaefer [13], are very close to the Hubble diagram $\mu_0(z)$ with $b = 1.1$ of this model. From the considered above, we see that the avoidance of the effect of cosmological time dilation means the transition to $b = 2.137 - 1 = 1.137$ - very close to that value. We may do now some predictions about the behavior of the universe in a frame of the standard model for high z comparing the theoretical Hubble diagrams (see Fig. 3): $\mu_0(z)$ of this model with $b = 1.137$ taking into account the effect of time dilation of the standard model (dash); and $\mu_c(z)$ for a flat Universe with the concordance cosmology by $\Omega_M = 0.27$ and $w = -1$ (dadot). You can see a good accordance of this diagrams up to $z \approx 4$; for higher redshifts we should expect the accelerated expansion again. The extra acceleration should decrease from big z to the smaller ones. We must bide new data from the future space missions to verify this prediction.

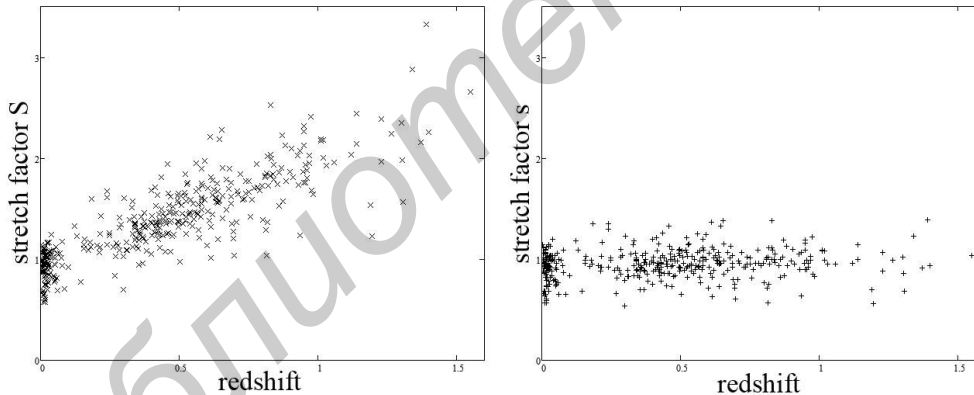

Figure 15.4: The observed values of stretch factor S without correction for time dilation (left panel, \times) and the corresponding values of stretch factor s corrected for time dilation (right panel, $+$); data are taken from Table 11 of [14] by Kowalski et al. (the Union compilation of SNe 1a).

Let us discuss briefly the distributions of stretch factor values of Supernovae 1a. Supernovae light curves are characterized by observers with the observed timescale stretch factor S . In the standard cosmological model, to

find the stretch factor s in the supernova rest frame one should divide S by $(1+z)$, where the factor $(1+z)^{-1}$ takes into account the effect of time dilation [7]. After it, the timescale of light curve is corrected by the factor S , when its magnitude is corrected only by the stretch factor s – in the standard model approach; but in any model with no time dilation it is necessary to use the factor S for both normalizations. On Fig. 4, the data from the Union compilation of SNe 1a by Kowalski et al. [14] are used to show the distributions of values of S and s for nearby SNe 1a (104 points with $z \leq 0.1$) and for high- z SNe 1a (294 points with $z > 0.1$). The values of the average $\langle s \rangle$ and σ for s are almost identical for these two subsamples: $\langle s \rangle$ is equal to 0.91 and 0.97, σ is equal to 0.143 and 0.144 for nearby and remote events. Usually, it is interpreted as the main argument in the proof that time dilation takes place [7]. But there are obvious physical arguments to show that the distributions of the stretch factor should be different for nearby and remote explosions: 1) the lower boundary of the distribution should rise with z due to increasing the luminosity distance; 2) the upper boundary should rise too because we have not a possibility to observe in the local volume very rare events, and they may be seen only in a very big volume. We see both these expected peculiarities on the left panel of Fig. 4, but not on the right one.

In this model, energy losses of any massive body due to forehead collisions with gravitons lead to the body acceleration by a non-zero velocity v : $w_0 = -ac^2(1 - v^2/c^2)$. For small velocities: $w_0 \simeq -Hc$, that may be connected with the Pioneer anomaly [15].

Astrophysical and cosmological observations may be used not only as confirmations of the standard model from new and new dark sides but in another manner: to clarify and to found better our knowledge of gravitation, perhaps, even beyond general relativity.

Bibliography

- [1] Kashlinsky, A. et al. *ApJ* 2010, *712*, L81-l85
[<http://arxiv.org/abs/0910.4958>].
- [2] Anderson, J.D. et al. *Phys. Rev. Lett.* 1998, *81*, 2858; *Phys. Rev.* 2002, *D65*, 082004; [gr-qc/0104064 v4].
- [3] Ivanov, M.A. In the book "Focus on Quantum Gravity Research", Ed. D.C. Moore, Nova Science, NY - 2006 - pp. 89-120; [hep-th/0506189], [<http://ivanovma.narod.ru/nova04.pdf>].
- [4] Ivanov, M.A. [arXiv:0901.0510v1 [physics.gen-ph]].
- [5] Ivanov, M.A. Gravitational asymptotic freedom and matter filling of black holes. Contribution to PIRT-09, Moscow, 6-9 July 2009 [<http://vixra.org/abs/0907.0036>].
- [6] Ivanov, M.A. [astro-ph/0606223] (see Chapter 8).
- [7] Perlmutter, S. et al. *Bull. Am. Astron. Soc.* 1997, *29*, 1351 [astro-ph/9812473v1].
- [8] Blondin, S. et al. *ApJ* 2008, *682*, 724-736 [arXiv:0804.3595v1].
- [9] Brynjolfsson, Ari [astro-ph/0406437v2].
- [10] Riess, A.G. et al. *ApJ* 2004, *607*, 665; [astro-ph/0402512].
- [11] Ivanov, M.A. Contribution to the VI Int. Workshop on the Dark side of the Universe (DSU2010), Guanajuato U., Leon, Mexico, 1-6 June, 2010 [<http://ivanovma.narod.ru/no-time-dilation10.pdf>] (see Chapter 14).

- [12] Ivanov, M.A. [astro-ph/0609518] (see Chapter 9).
- [13] Schaefer, B.E. [astro-ph/0612285].
- [14] Kowalski, M. et al. *ApJ* 2008, *686*, 749-778; [arXiv:0804.4142v1 [astro-ph]].
- [15] Ivanov, M.A. [arXiv:0711.0450v2 [physics.gen-ph]] (see Chapter 10).

Библиотека БГУИР